

FOREG

Library shelving systems



ECOSPACE

Competence speaks volumes

Whether it is readers browsing in the open-access part of a library or librarians going through archives and store rooms – to both groups Forster delivers superior know-how combined with state-of-the-art engineering and superb creativity. Flexibility and efficiency are the rock-solid foundation that our clients can rely on.

FOREG library shelving systems unite individual design with professional execution at all levels, impressing by their functionality and user-friendliness. Competence in consulting joins forces with distinction in design and execution to provide long-term innovative quality solutions.



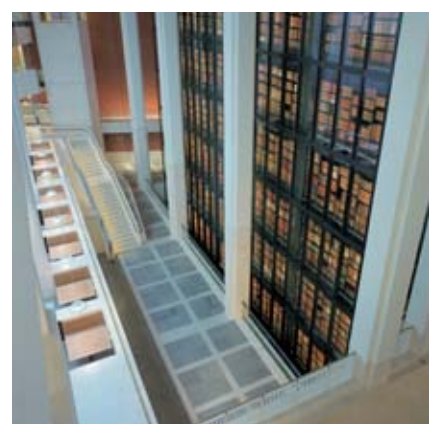

Function in its most attractive form

Libraries are a great place to fuse aesthetics with function. The shelving of a library is not just designed to serve order and clarity, but it is also an essential part of the library's inner workings.

Achieving a harmonious ambience is therefore at the starting point of our planning efforts. Our products are carefully designed modular systems, perfectly matched and complete with a large range of accessories. From mobile to stationary systems, from shelving brackets to labels – city, county, national and university libraries rely on us to meet their requirements.

Centrally supported shelving system

Modular structure for more space



End panel
timber

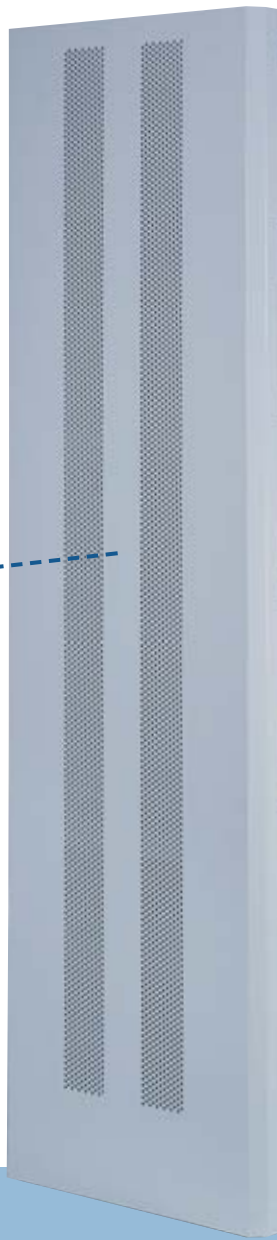

End panel
steel, 6 mm perforated



End panel
solid steel



Timber folding table
side-fitted

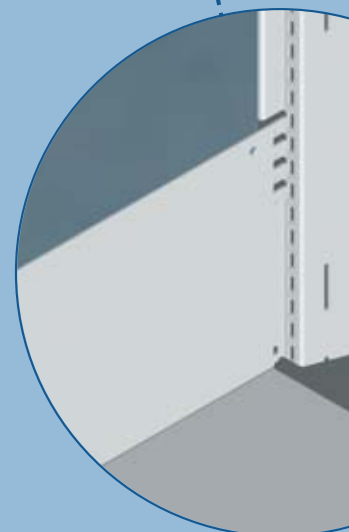

m FOREG 1000

Advantages at a glance:

- Slot-in centrally supported shelf with paired slots
- Guide rail for simple rearrangement of shelves
- High stability
- Shelves adjustable in increments of 15 mm
- No tools required to assemble accessories
- No limits to rearranging and extending the units
- Available as a mobile unit (can be retro-fitted)
- Open-access system
- Excellent ventilation
- Simple design
- Open at all sides
- Range of end panels

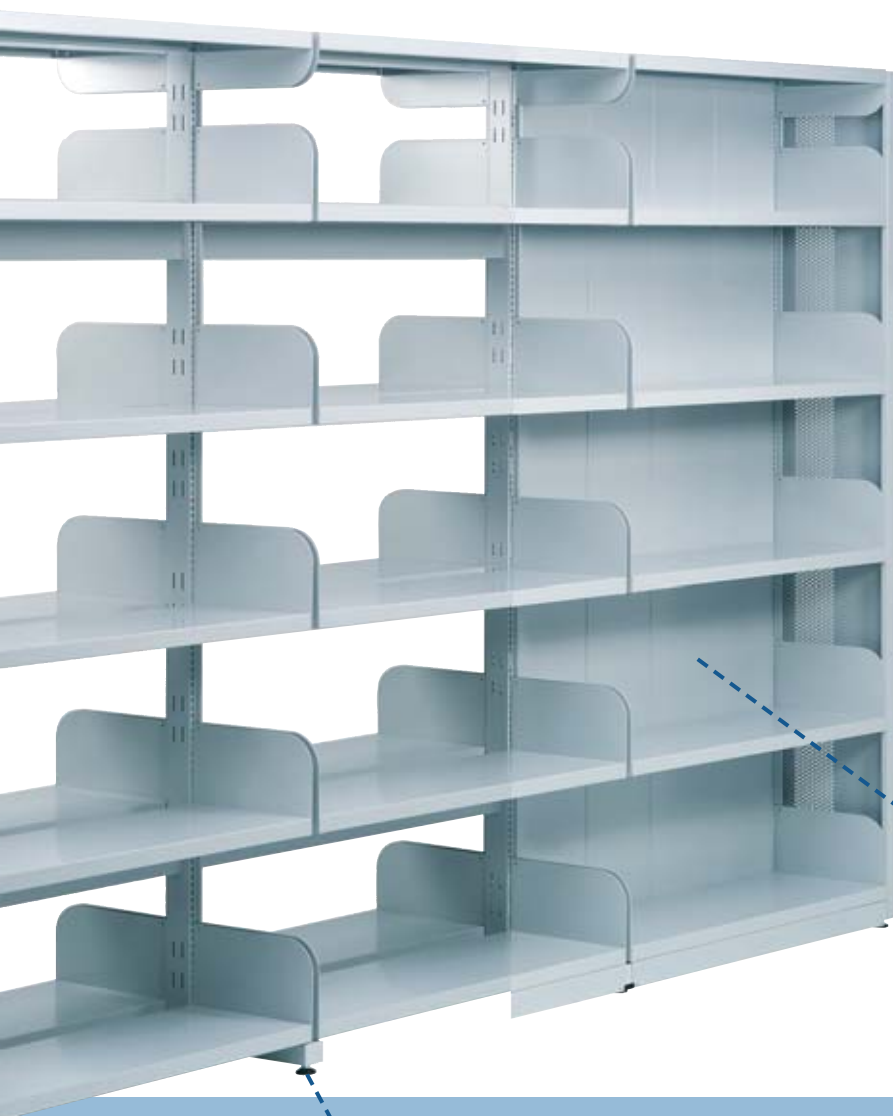

Height-adjustable base

Partition, 6 mm perforated steel
Partition, solid steel

Guide rail for simple shelf assembly

For a stable future

The height-adjustable base optimally compensates for uneven flooring and guarantees maximum stability. The solid combination of shelves and vertical dividers ensures stability, further enhanced by the guide rail.

Framed shelving system FOREG

Perfect down to the last detail



End panel
timber

End panel
steel, 6 mm perforated

End panel
solid steel

The wide variety of end panels and frames for use as design elements is typical of FOREG 2000, allowing you to achieve your own customised solution. Your choices are numerous: perforated end panels will ensure excellent ventilation; interior cover panels are available in many designs – choose from the options at your disposal and enjoy the unique quality, paired with sophistication and efficiency.

2000

Benefits:

- Slot-in shelving, single or double sided
- Can be converted into mobile unit
- High stability
- Shelves adjustable in increments of 20 mm
- No tools required for assembly
- Arrangement customised to your requirements
- Extended modular system
- Open and closed frames
- Accessories interchangeable with FOREG 1000

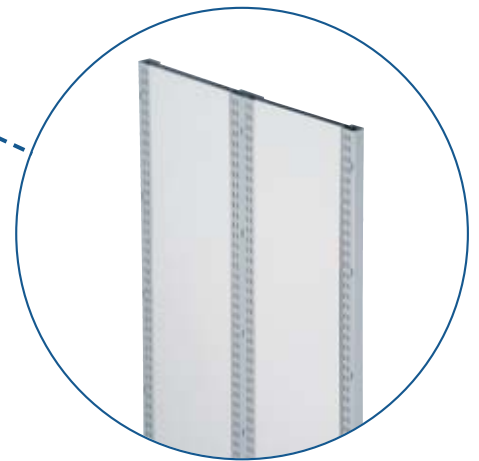
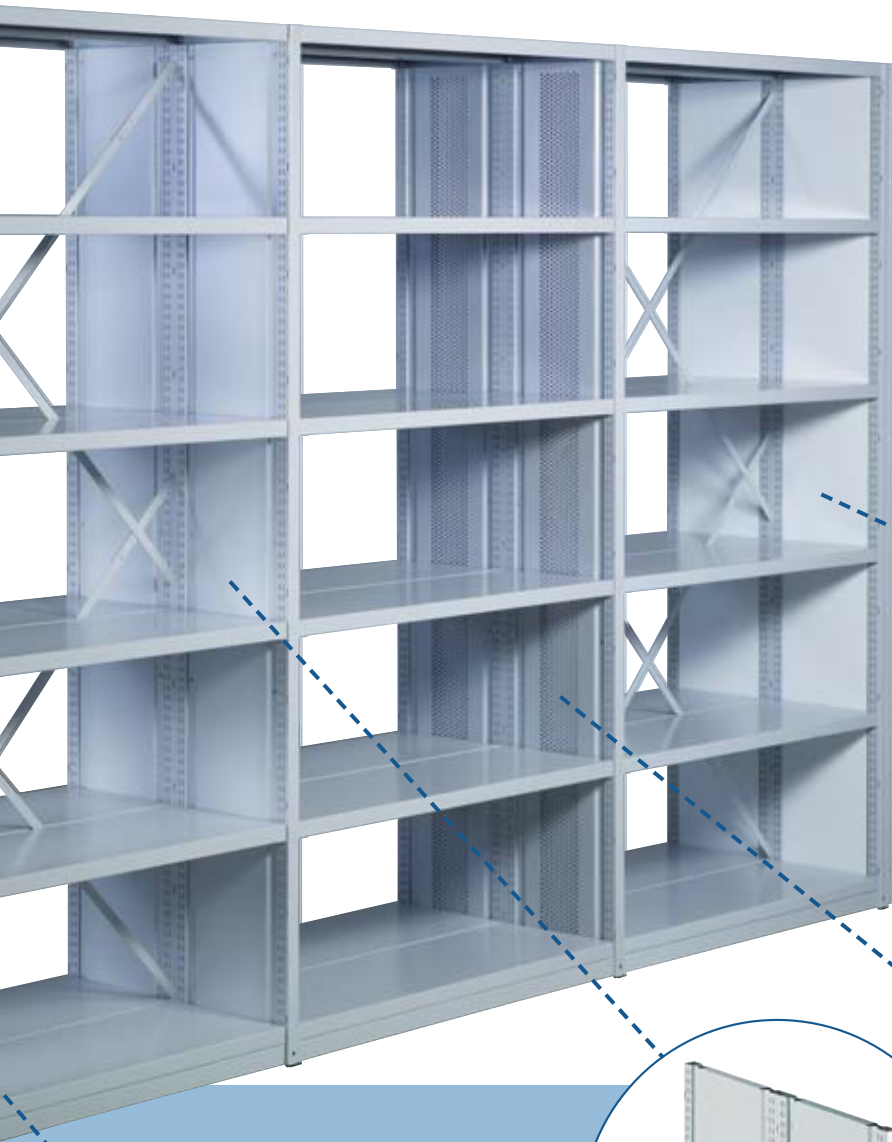

Closed frame with coated hardboard

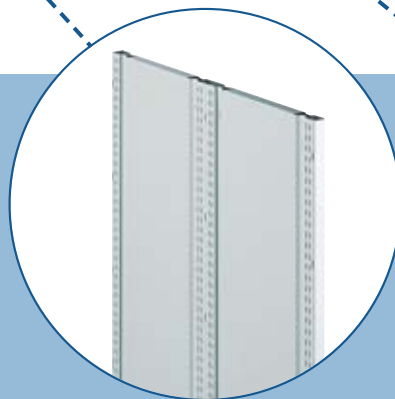

Closed frame, solid steel

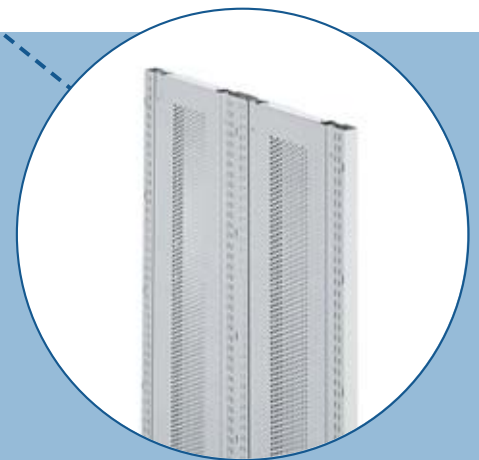

Closed frame, 6 mm perforated steel

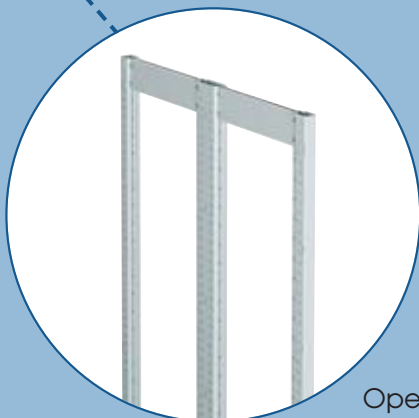

Open frame

The shelf

It has what it takes

Shelves come in timber or steel, depending on the load and aesthetic requirements. High-quality materials and superior workmanship guarantee a long and useful life. The intelligent design adapts optimally to its overall appearance, ambience and surrounding. The strong connection of shelf and vertical divider provides reliable stability in all situations.



Timber shelf



Top shelf



Steel shelf

Accessories for all seasons

Clients can trust us to find a solution for their requirements: FOREG library shelving accessories exist for many applications. Accessories are compatible with centrally supported FOREG 1000 systems as well as FOREG 2000 framework systems.



Bridging element



Low back stop



High back stop



Timber worktop
(to be used only in FOREG 1000)



Pull-out shelf

Bookends

Getting books to stay



Side stop, steel



Side stop, plastic

Our bookends ensure that books will not fall from their proper place. Choose from a large selection of models that keep books in line: sliding and angular ends in a range of heights and widths; suspended bookends to prevent material from falling over. Side stops, which double as limiters in open frames, are easy to adjust in height and guarantee optimum ventilation.



Suspended divider, rod type



On-shelf divider



Angled bookend



Angled bookend with a stop

Magazine display

Impossible to overlook

20° angle

30° angle

40° angle

50° angle

60° angle



Angled magazine shelf



Magazine display shelf



Magazine display



Inclined shelf
(for large-sized formats)



Magazine box

Everything within sight: With magazine shelves arranged at a variety of angles, the reader has the best possible view and gets to see the magazines in their best light. The shelves fit all heights, reflecting individuality and professionalism in all fields of application.

Labelling

Finding your way

In a library, good labelling is paramount. Labelling panels and strips are available in several designs, using paper inserts for easy identification. Panels of sizes A4 and A5 can be positioned as portrait or landscape format.



Flag-type sign



Cardholder



Cardholder

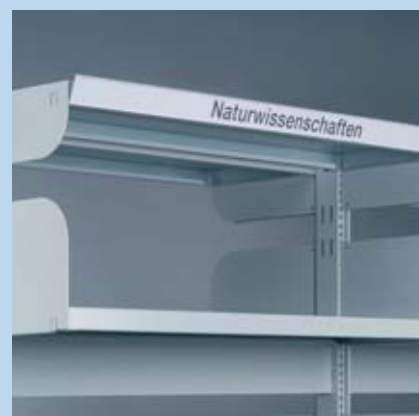

Labelling strip for shelving bays fitted to the top shelf

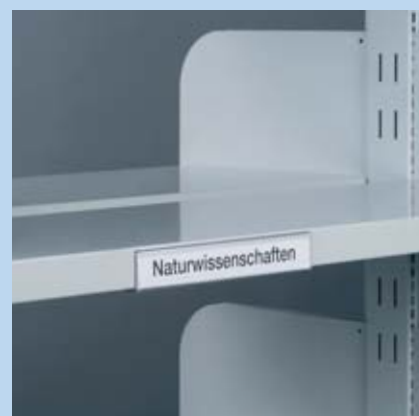

Labelling strip for shelves for easy fitting

Lighting

Light elements are harmoniously integrated in the bay to emphasise and underline its appearance. A choice of systems are available that can be customised to your ideas. Clear lines and aesthetic design: our hallmark and a visible expression of a very special ambience.



Individual lighting

End panels

Accentuate the special

We offer a large choice of end panels – whether perforated or plain steel, timber or glass – you'll find just what you need to complement the surrounding architecture. You define your requirements, we find the matching solution.



Glass end panels

Special accessories



Book trolley: steel with three shelves and stops on one or both sides.

Room to move

The more books you have the more space will be needed to bring out the best in them. Our mobile shelving is the ideal solution to get the most out of a given space: it offers almost double the storage space of comparable static systems. Such space-saving solutions are an investment into the future, because space is becoming ever more precious and needs to be used well.

Ask for our brochure on the FOREG 2000 system.



Save space to save costs

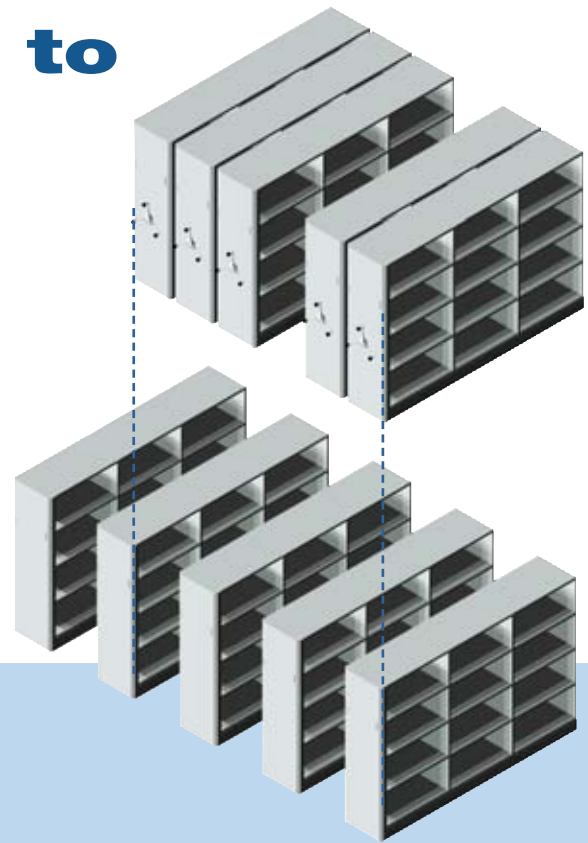

Making the best out of a given space will minimise costs substantially. Our solutions provide economy combined with innovative design.

Mobile shelving allows you to open only the aisles required: accessible when you need it, closed when you want it: mobile shelving is tailored exactly to your needs.

Quality assurance

Our production complies with requirements under:

- RAL quality mark
RAL-RG614/1
RAL-RG614/4
- GS mark (certified safety)
- Quality management system
as per ISO 9001:2008
- Environmental management system
as per ISO 14001:2004



Surface

All metal components are galvanised and powder-coated in RAL 7035.

Centrally supported shelving system FOREG

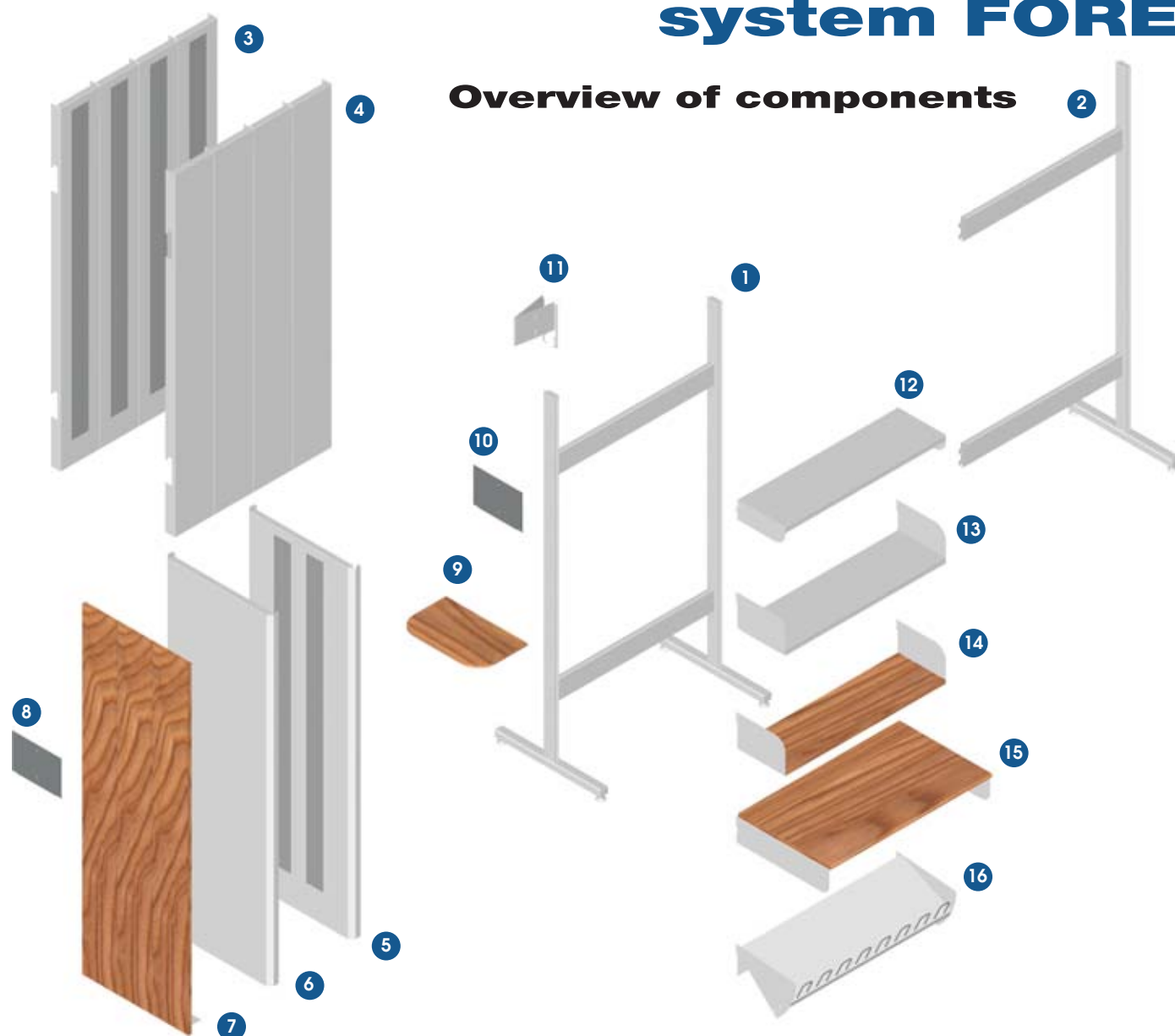

Overview of components

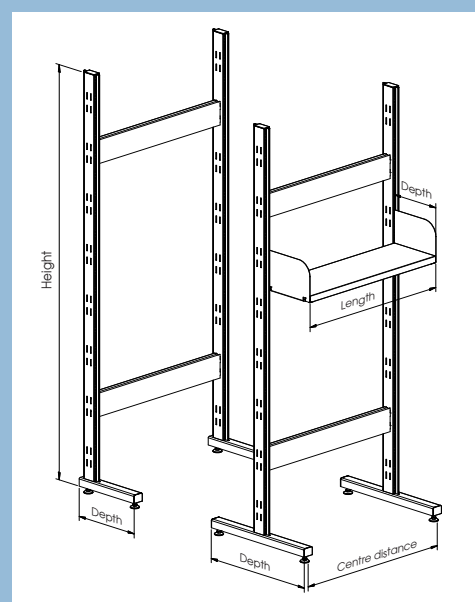

Dimensions

Unit heights: 1967 mm
2207 mm

Unit depths: 321,5 mm (single-sided)
371,5 mm

Unit depths: 543 mm (double-sided)
643 mm

Bay widths: 759 mm (nominal width,
900 mm centre-to-centre
1000 mm of uprights distance)

Shelves: 739 mm (length)
880 mm
980 mm

Shelves: 250 mm (depth)
300 mm
350 mm
400 mm

1000

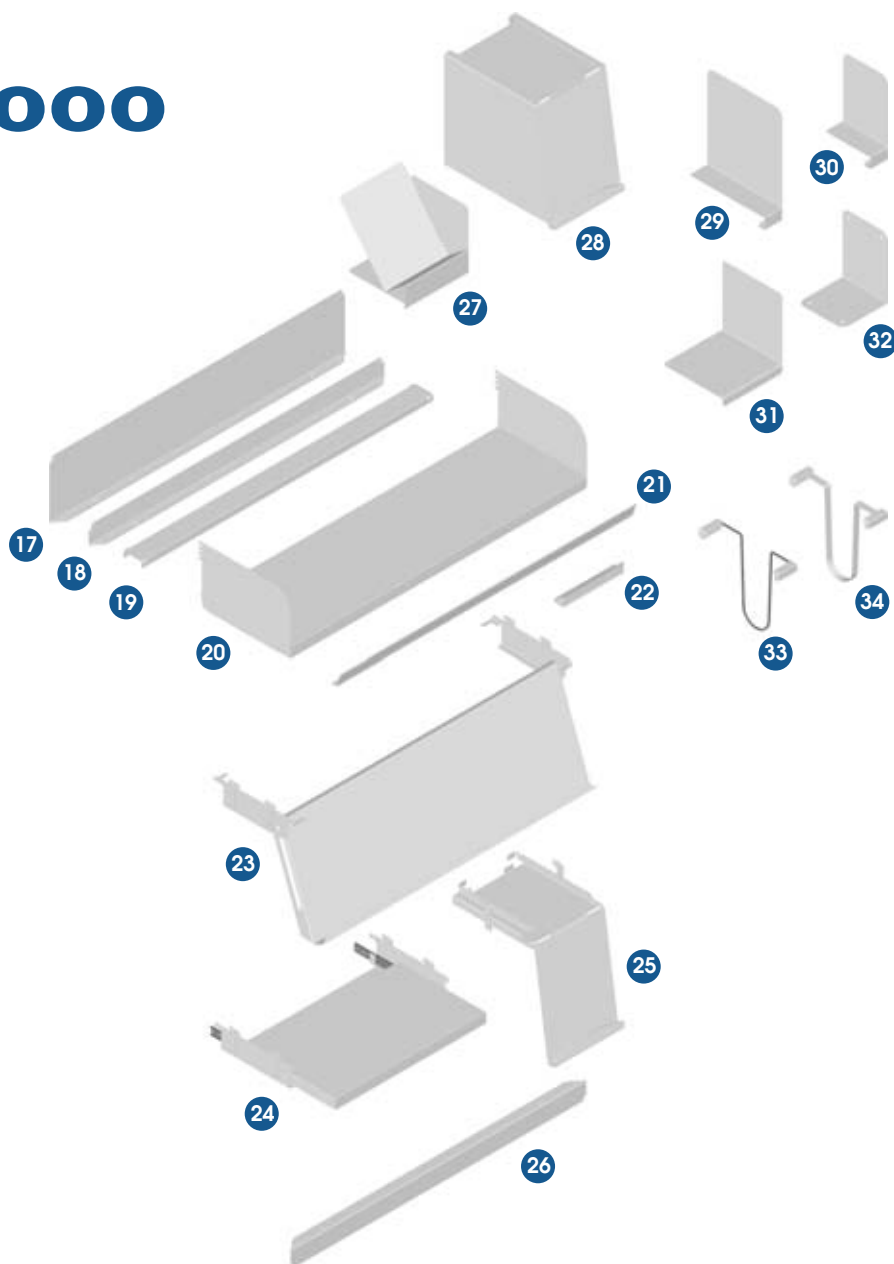

- 1 "starter" bay
- 2 add-on bay
- 3 back panel, perforated steel
- 4 back panel, solid steel
- 5 end panel, perforated steel
- 6 end panel, solid steel
- 7 end panel, timber
- 8 Signage panel DIN A5/A4 – portrait/landscape
- 9 folding table, timber
- 10 Signage panel DIN A5/A4 – portrait/landscape
- 11 flag-sign panel
- 12 top shelf
- 13 shelf, steel
- 14 shelf, timber
- 15 worktop, timber
- 16 angled magazine shelf
- 17 back stop, high
- 18 back stop, low
- 19 bridging element
- 20 shelf, steel
- 21 bay labelling
- 22 shelf labelling
- 23 inclined shelf
- 24 pull-out shelf
- 25 magazine display shelf
- 26 steel plinth
- 27 magazine display
- 28 magazine box
- 29 on-shelf divider, large
- 30 on-shelf divider, small
- 31 angled bookend with stop
- 32 angled bookend
- 33 suspended divider, rod type
- 34 suspended divider, flat steel

Technical data

Support profile: steel section with guide rail

Shelf: triple-folded sheet steel with side supports
timber with side supports

Height-adjustable in increments of 15 mm

Floor compensation: feet, approx. 20 mm, height-adjustable

Acceptable loads

Bay load: single-sided bay max. 400 kg
double-sided bay max. 800 kg

Shelf load: max. 70 kg per metre

Frame shelving system FOREG

Overview of components

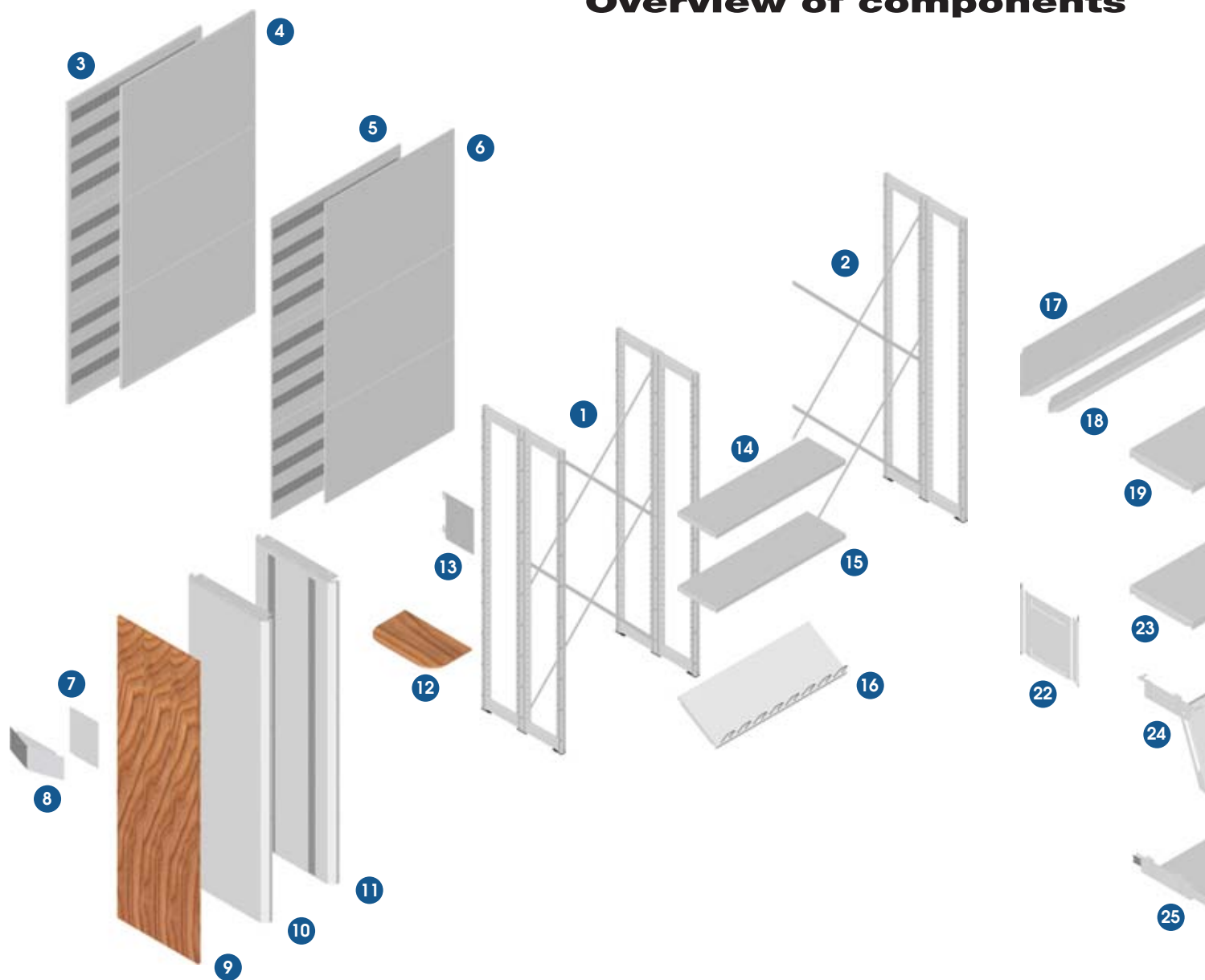

- 1 "starter" bay
- 2 add-on bay
- 3 rear panel, perforated steel
- 4 rear panel, solid steel
- 5 back panel, perforated steel
- 6 back panel, steel
- 7 cardholder
DIN A5/A4 – portrait/landscape
- 8 protruding cardholder
- 9 end panel, timber
- 10 end panel, steel
- 11 end panel, perforated steel
- 12 folding table, timber
- 13 cardholder
DIN A5/A4 – portrait/landscape
- 14 top shelf
(steel shelf design)
- 15 shelf, steel
- 16 angled magazine shelf
- 17 back stop, high
- 18 back stop, low
- 19 shelf, steel
- 20 bay labelling
- 21 shelf labelling
- 22 shelf divider, steel/hardboard
- 23 shelf, perforated steel
- 24 inclined shelf
- 25 pull-out shelf
- 26 magazine display shelf
- 27 steel plinth
- 28 magazine display

2000

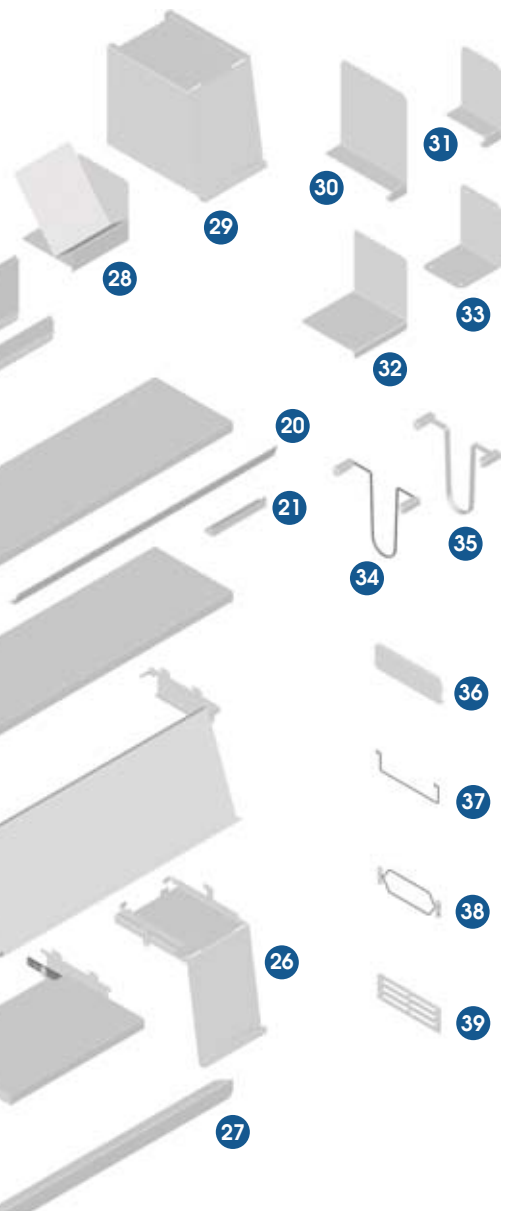

Dimensions

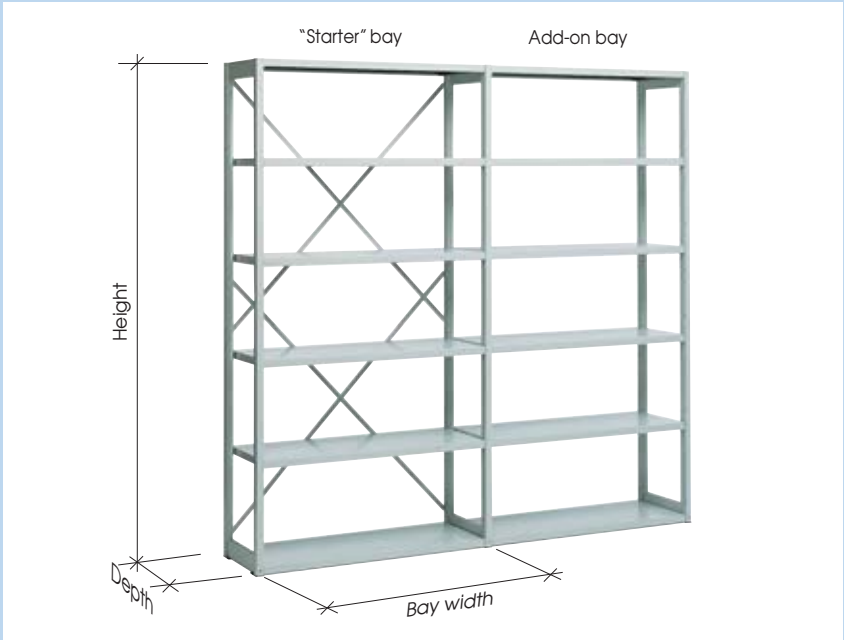

Heights: (+ 3 mm plastic base plate)	1632 mm	Depths:	250 mm	500 mm
	1952 mm		300 mm	600 mm
	2232 mm		350 mm	700 mm
	2592 mm		400 mm	800 mm
	2952 mm		450 mm	
Bay width:	900 mm			
	1000 mm			
	1100 mm			
	1200 mm			

Technical data

Frame profile: box section steel profile

Shelf: triple folded steel

Height-adjustable in increments of 20 mm

Acceptable loads

Bay load: max. 1300 kg

Shelf load: max. 65–100 kg (depending on shelf size)
(up to 150 kg when reinforced shelving is used)

- 29 magazine box
- 30 on-shelf divider, large
- 31 on-shelf divider, small
- 32 angled book-end, with stop
- 33 angled book-end
- 34 suspended divider, rod type
- 35 suspended divider, flat steel
- 36 side stop, steel
- 37 side stop, rod type
- 38 side stop, rod type
- 39 side stop, plastic

References



Centre for Basic Medical Research, Graz



Freie Universität Berlin



University of Mannheim



Czech Technical University, Prague

Our library systems are in use world-wide, confirming the fact that Forster stands for high quality and vast experience - which all of our customers benefit from. Intense personal commitment, full attention to detail and first-rate service combine to produce solutions that meet and exceed our customers' high expectations.

University of Stirling, Scotland



Grimm Library, Berlin



Senate House Library - University of London



Innovation unlimited



St. Andrews University, Scotland



Middlesex University, London

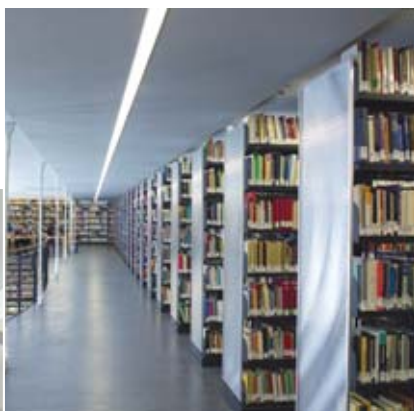

Ludwig Maximilian University, Munich

To turn vision into practical reality, it is necessary to harness a wealth of good ideas. Requirements must be analysed to reach innovative solutions. The reference projects shown here are a small selection from our international clientele whose different expectations we have been able to fulfil.

Max Planck Institute, Munich



Czech Technical University, Prague



University of Heidelberg



Swiss National Library

Optimal solutions for customers:



Static shelving systems

for archiving, administration and storage



Mobile shelving systems

for archiving, administration and storage



Picture storage

extendible for the storage of paintings
in archives and museums.



FORSTER Ecospace Limited
Masons Gate, Townsend,
Marsh Gibbon, nr Bicester, Oxon OX27 0EY
Tel: 01869 278002, Fax: 01869 278003
e-mail: sales@ecospace.co.uk, www.ecospace.co.uk

ECOSPACE

Mobile, static & library shelving systems

ST 58023
07/2011_A2
Products are subject to changes.