

DAY	DATE	DEPARTMENT / CONTRACTOR	ACTIVITY	START TIME	FINISH TIME	LOCATION	GC RESPONSIBILITY	CREW	VEHICLE	PLANT
Monday	19/12/2016	Site	Plant delivery	07:00		Production Boneyard	Max		Artic	FLT
		ALL	Load in & setup office	08:00	10:00	Production Office	All GC Staff			
		Star Events	Star Events T1 18t onsite (C4Di)	11:00		The Deep	KP, Dom, Jimax			
		Star Events	Build C4Di structure	11:30	14:00	The Deep	KP, Dom, Jimax	4		
		Site	Cabin delivery	09:00		Production Boneyard	Max		Artic	FLT
		Star Events	Star Events T2 18t onsite & crossload	14:00		Production Boneyard	KP, Dom, Jimax		7.5t	FLT
		Star Events	Build SLS structure	14:00	18:00	Scale Lane Staith	KP, Dom, Jimax	4	7.5t	
		Star Events	Reload for QVS Structures	19:00	20:00	Production Boneyard	KP, Dom, Jimax	4	7.5t	FLT
		Star Events	Unload QVS structures	19:00	20:00	Queen Victoria Square	KP, Dom, Jimax	4	7.5t	FLT
		Site	Toilet delivery			Production Boneyard	Max		Artic	FLT
		Site	Heras delivery			Production Boneyard	Max		Artic	FLT / 7m Tele
		Site	Heras delivery			Queen Victoria Square	Max	6	Artic	FLT
		Site	Heras install			Underpass	Max	6		FLT
		Site	Flatbed collection at Foxy Rentals			Production Boneyard	Max & Joe		7.5t	
Site	Skip delivery			Production Boneyard	Max		7.5t			
Site	Concials built with ballast			Production Boneyard	Max		7.5			
Tuesday		Star Events	Build monument & FOH structures	08:00	13:00	Queen Victoria Square	KP, Dom, Jimax	4	Artic	
		Star Events	Star deliveries continue to QVS all day	08:00	19:00	Production Boneyard	KP, Dom, Jimax		7.5t	
		Site & Production	External clean of all shops	08:00	18:00	Whitefriar Gate	KP, Dom, Jimax	3		
		ALL	Load in & setup office	08:00	10:00	Production Office			3.5t	
		Site	Cabin delivery	09:00		Production Boneyard	Max		Artic	
		Midas	Towerlight drops	15:00		Queen Victoria Square	Max		4x4	
		Star Events	Star Events T3 18t unload (PA Towers)	19:00	20:00	Queen Victoria Square	KP, Dom, Jimax	4	Artic	
		Midas	Generator (Towable) drop for QVS			Queen Victoria Square	Max		4x4	7m Tele
Wednesday	21/12/2016	Star Events	Install 4th Monument tower once Eurovia com	08:00	19:00	Queen Victoria Square	KP, Dom, Jimax	4		FLT / PICKER
		Star Events	Install Muesum PA masts and left hand town h	08:00	20:00	Queen Victoria Square				FLT / PICKER
		Star Events								
		Site & Production	Internal clean of all shops	08:00	18:00	Whitefriar Gate	Max & Dom	3		
		Site	Drop Zeb Yard Fencing	08:00	18:00	Zeb	Max		flatbed	
		Production	Build Unit 9 projector rigging	10:00	11:00	Whitefriar Gate	Dom			
		Production	Feonic delivery (sound equipment)	12:00		Production Office	Dom		3.5t	
		Star Events	Install Ferens PA masts (site to assist)	18:00	22:00	Queen Victoria Square	Max			FLT/PICKER
		Site	Fencing layout for towers	20:00	22:00	Zebedee's Yard	Max	4		
Midas	Delivery of Generator sets to QVS - tbc			Queen Victoria Square	Max			HIAB		
Site	Change Heras fence line to Phase 2	20:00	22:00	Queen Victoria Square	Max	4				
Thursday	22/12/2016	Star Events	Star Events T4 18t unload (LX towers)	08:00	13:00	Zebedee's Yard	KP, Dom, Jimax	4		
		Star Events	Star Events T5 18t unload (kentledge)	08:00	13:00	Production Boneyard	KP, Dom, Jimax	4		926
		Star Events	Build LX Towers	08:00	18:00	Zebedee's Yard	KP, Dom, Jimax	4		17m Tele / Picker
		Star Events	Install right Town Hall mast				Max			FLT/PICKER
		Tube	Tube cable install	08:00	18:00	Queen Victoria Square	Dom & Tom			Picker
		Site	Fenicing rework if required	08:00	10:00	Zebedee's Yard	Max	2	Flat bed	
		Midas	Generator drop for rigging power	08:00		Zebedee's Yard	Max		4x4	
		Production	UK LED Install on Maritime & City Hall	08:00	20:00	Queen Victoria Square	Dom			Picker
Production	Screen windows in QVS	10:00	18:00	Queen Victoria Square	KP & DOM	2		Picker		

		Production	Install Pro Diffusion in Units 9, 16,17	12:00	18:00	Whitefriar Gate	Dom & Tom	2		
		Star Events	Load rigging for underpass	18:00	18:30	Production Boneyard	KP, Dom, Jimax	4	7.5t	926
		Star Events	Unload rigging for underpass	19:00	19:30	Underpass	KP, Dom, Jimax	4	7.5t	926
		Midas	All cable ramp complete	08:00	14:00	Queen Victoria Square	Max			
		Production & Bluman	Projector delivery (time TBC)			Production Office	Dom			
Friday	23/12/2016	Site & Production	Rigging install	08:00	13:00	Underpass	Max & Dom	4		17m w/basket
		Production	Install Feonic transducers in Units 16,17,20,23	12:00	18:00	Whitefriar Gate	Dom & Tom			
		Production & Creative	Cube mapping test	12:00	22:00	Whitefriar Gate	Dom & Niccy			
		Site	Site snagging jobs			Zebedee's Yard	Max	2	Flat bed	
		Midas	Move rigging power generators to boneyard			QVS/ZEB				
		Midas	Generator drop for rigging			Underpass				17m
		Star	Underpass Install			Underpass				17m w/basket
Saturday	24/12/2016		NO ACTIVITY SCHEDULED							
Sunday	25/12/2016		NO ACTIVITY SCHEDULED							
Monday	26/12/2016	ALL	Crew and staff travel back to Hull	16:00	18:00		ALL			
		Bluman	Bluman T1 & T2 arrive onsite	18:00	18:00	Production Boneyard	Dom & Tom			
		Midas	Cabling work to be advanced	08:00	18:00	Various sites	Midas			
		Site	Reset Heras Fenceline to Phase 3	08:00	09:00	Queen Victoria Square	Max	4		
		Star Events	Build PA Risers	08:00	11:00	The Deep	Dom & Max			
		Midas	Power up projectors	08:00	16:00	Queen Victoria Square				
		Midas	Power up projectors & drop gen	08:00	16:00	The Deep				
		Midas	Power up projectors	08:00	16:00	Underpass				
		Midas	Power up projectors & drop gen	08:00	16:00	Scale Lane Staith				
		Bluman	Bluman T1 arrives onsite & tips	09:00	10:00	Queen Victoria Square	Dom & Tom	6	Y	FLT
		Bluman	Bluman T2 arrives onsite & tips	09:00	10:00	The Deep	Dom & Tom	6	Y	FLT
		Scenic	Build circular riser	09:00	12:00	Underpass	Dom			
		DBN	Tip & install The Deep LX	09:00	12:00	The Deep	Dom & Tom	6		
		Bluman	Bluman techs onsite to intall PJ's and control	10:00	14:00	Queen Victoria Square	Dom & Tom	6		
		Bluman	Bluman techs onsite to intall PJ's and control	10:00	14:00	The Deep	Dom & Tom	6		
		Star	To build PA Risers	10:30	12:00	The Deep				
		Bluman	Crossload Underpass & SLS from T2	11:00	12:00	Production Boneyard	Dom & Tom	6	7.5t	FLT

Tuesday	27/12/2016	Tube	Tube T1 arrives onsite, Tips in boneyard	11:00	12:00	Production Boneyard	Dom & Tom	2		
		DBN	DBN T1 arrives	11:00		Queen Victoria Square	Dom & Tom			
		Bluman	Install Underpass PJ's and control	12:00	16:00	Underpass	Dom & Tom	6		17m & basket
		Bluman	Install PJ's & control	12:00	16:00	Scale Lane Staith	Dom & Tom	6		7m Tele
		Tube	Crossload QVS onto LWB	12:00	12:30	Production Boneyard	Dom & Tom	2		
		Production	Screen install	12:00	20:00	Underpass	Dom			
		DBN	Tip & install rooftop LX	12:00	18:00	Queen Victoria Square	Dom & Tom	6		
		DBN	Tip & Install LX	12:00	19:00	Underpass	Dom & Tom	3	Y	Picker
		Tube	Install QVS audio	13:00	16:00	Queen Victoria Square	Dom & Tom	2		
		Bluman	Crossload Whitefriar Gate video	14:00	14:30	Production Boneyard	Dom & Tom	6		
		Bluman	Install Whitefriar Gate video	14:30	18:00	Whitefriar Gate	Dom & Tom	6	LWB	
		DBN	DBN T1 to Boneyard	16:00	17:00	Production Boneyard	Dom & Tom	6		
		Bluman	Video sytem checks on all sites	16:00	20:00	All	Dom & Tom			
		Tube	Crossload & distribute kit for all sites	16:00	19:00	All	Dom & Tom	2		
		DBN	Tip & install monument LX	17:00	19:00	Queen Victoria Square	Dom & Tom	6		
Midas	Power DBN LX	18:00	19:00	Zebedee's Yard						
Site	General jobs 2 x drivers				Max	2				
Site	Barriers around risers			The Deep						
Wednesday	28/12/2016	Tube	Install the Underpass audio	08:00	18:00	Underpass	Dom & Tom			
		Tube	Install the Deep audio	08:00	18:00	The Deep	Dom & Tom	2		7m Tele
		Tube	Install Whitefriar audio	08:00	18:00	Whitefriar Gate	Dom & Tom			
		Tube	Install Zebedee's yard audio	08:00	18:00	Zebedee's Yard	Dom & Tom			
		Tube	Install SLS audio	08:00	18:00	Scale Lane Staith	Dom & Tom			
		DBN	Install LX	08:00	13:00	Zebedee's Yard	Dom	6		17m & basket
		DBN	Crossload The Underpass LX	13:00	14:00	Production Boneyard	Dom & Tom	6		
		DBN	Tip & install The Underpass LX	14:00	19:00	Underpass	Dom & Tom	6		
		Bluman	Video general tidy up	14:00	18:00	All	Dom & Tom	2		
		Bluman	Video line up on all sites	16:00	04:00	All	Dom & Tom			
		Production & DBN	LX programming	16:00	22:00	Underpass	Dom & Durham			
		DBN	Crossload Whitefriar Gate LX	17:00	17:30	Production Boneyard	Dom & Tom			
		DBN	Tip & install Whitefriar Gate LX	17:30	19:00	Whitefriar Gate	Dom & Tom			
		Site	General jobs 2 x drivers				Max	2		
		Midas	Generator drop & wire up the 'nose'			The Deep				
Thursday	29/12/2016	Creative	All artists on site	09:00		All	Niccy			
		Production	System tuning	10:00	12:00	All	Dom & Tom			
		Production	Soundcheck	10:00	16:00	Zebedee's Yard	Dom			
		Production	LX programming	16:00	23:59	Queen Victoria Square	Dom & Durham			
		Production	Audio & Video checks	16:00	23:59	Queen Victoria Square	Dom			
		Production	Audio & Video checks	16:00	19:00	Whitefriar Gate	Dom			
		Production	Audio & Video checks	16:00	23:59	The Deep	Dom			
		Production	Audio & Video checks	16:00	23:59	Underpass	Dom			
		Production	Audio & Video checks	16:00	23:59	Scale Lane Staith	Dom			
		Site	General jobs 2 x drivers			All	Max	2		
		Production & EM	Noise propogation testing	12:00	16:00	All	KP, Dom & Kate			
		Production	LX Programming	16:00	21:00	Zebedee's Yard	Dom			
		Production	Audio & Video checks	16:00	22:00	Queen Victoria Square	Dom			

Friday	30/12/2016	Production	Audio & Video checks	16:00	22:00	Underpass	Dom				
		Production	Audio & Video checks	16:00	22:00	Scale Lane Staith	Dom				
		Production	Audio & Video checks	16:00	22:00	The Deep	Dom				
		Production	LX Programming	21:00	23:00	The Deep	Dom				
		Production	Soundcheck	21:00	22:00	Zebedee's Yard	Dom				
		Production	Crew dinner	22:00	23:00	All	Dom				
		Production	Full dress rehearsals on all sites	23:00	23:59	All	Dom				
		Site	General jobs 2 x drivers				Max	4			
		Production									
Saturday	31/12/2016	Site	Site crew emergency cover (TBC)				Max	2			
Sunday	01/01/2017	Production	All technical staff onsite	12:00							
		ALL	SHOW LIVE	16:00	22:00	Queen Victoria Square	All				
		ALL	SHOW LIVE	16:00	22:00	Whitefriar Gate	All				
		ALL	SHOW LIVE	16:00	22:00	Zebedee's Yard	All				
		ALL	SHOW LIVE	16:00	22:00	Scale Lane Staith	All				
		ALL	SHOW LIVE	16:00	22:00	Underpass	All				
		ALL	SHOW LIVE	16:00	22:00	The Deep	All				
Monday	02/01/2017	ALL	SHOW LIVE	16:00	22:00	Queen Victoria Square	All				
		ALL	SHOW LIVE	16:00	22:00	Whitefriar Gate	All				
		ALL	SHOW LIVE	16:00	22:00	Zebedee's Yard	All				
		ALL	SHOW LIVE	16:00	22:00	Scale Lane Staith	All				
		ALL	SHOW LIVE	16:00	22:00	Underpass	All				
		ALL	SHOW LIVE	16:00	22:00	The Deep	All				
Tuesday	03/01/2017	ALL	SHOW LIVE	16:00	22:00	Queen Victoria Square	All				
		ALL	SHOW LIVE	16:00	22:00	Whitefriar Gate	All				
		ALL	SHOW LIVE	16:00	22:00	Zebedee's Yard	All				
		ALL	SHOW LIVE	16:00	22:00	Scale Lane Staith	All				
		ALL	SHOW LIVE	16:00	22:00	Underpass	All				
		ALL	SHOW LIVE	16:00	22:00	The Deep	All				
		ALL	SHOW LIVE	16:00	22:00	Queen Victoria Square	All				
		ALL	SHOW LIVE	16:00	22:00	Whitefriar Gate	All				
		ALL	SHOW LIVE	16:00	22:00	Zebedee's Yard	All				

Wednesday	04/01/2017	ALL	SHOW LIVE	16:00	22:00	Scale Lane Staith	All			
		ALL	SHOW LIVE	16:00	22:00	Underpass	All			
		ALL	SHOW LIVE	16:00	22:00	The Deep	All			
Thursday	05/01/2017	ALL	SHOW LIVE	16:00	22:00	Queen Victoria Square	All			
		ALL	SHOW LIVE	16:00	22:00	Whitefriar Gate	All			
		ALL	SHOW LIVE	16:00	22:00	Zebedee's Yard	All			
		ALL	SHOW LIVE	16:00	22:00	Scale Lane Staith	All			
		ALL	SHOW LIVE	16:00	22:00	Underpass	All			
		ALL	SHOW LIVE	16:00	22:00	The Deep	All			
Friday	06/01/2017	ALL	SHOW LIVE	16:00	22:00	Queen Victoria Square	All			
		ALL	SHOW LIVE	16:00	22:00	Whitefriar Gate	All			
		ALL	SHOW LIVE	16:00	22:00	Zebedee's Yard	All			
		ALL	SHOW LIVE	16:00	22:00	Scale Lane Staith	All			
		ALL	SHOW LIVE	16:00	22:00	Underpass	All			
		ALL	SHOW LIVE	16:00	22:00	The Deep	All			
Saturday	07/01/2017	ALL	SHOW LIVE	16:00	22:00	Queen Victoria Square	All			
		ALL	SHOW LIVE	16:00	22:00	Whitefriar Gate	All			
		ALL	SHOW LIVE	16:00	22:00	Zebedee's Yard	All			
		ALL	SHOW LIVE	16:00	22:00	Scale Lane Staith	All			
		ALL	SHOW LIVE	16:00	22:00	Underpass	All			
		ALL	SHOW LIVE	16:00	22:00	The Deep	All			
		Bluman	Strike all video (all Bluman crew)	21:00	00:00	Queen Victoria Square	KP, Dom, Jimax	6		
		DBN	Strike all LX (all DBN crew)	21:00	00:00	Queen Victoria Square	KP, Dom, Jimax	6		
		Tube	Strike all audio (all tube crew)	21:00	00:00	Queen Victoria Square	KP, Dom, Jimax	4		
		Star Events	Strike PA towers (sr Maritime 1st)	23:00	00:00	Queen Victoria Square	KP, Dom, Jimax	4		
		Star Events	Strike FOH & Projection towers	23:00	04:00	Queen Victoria Square	KP, Dom, Jimax	4		
		Star Events	Strike monument projection platforms	23:00	04:00	Queen Victoria Square	KP, Dom, Jimax	4		
		Star Events	Ferry equipment to boneyard	23:00	04:00	Production Boneyard	KP, Dom, Jimax	4	7.5t	
		Star Events	T3 to site to collect PA towers	23:00	04:00	Queen Victoria Square	KP, Dom, Jimax	4		
		Star Events	QVS site clear	23:00	04:00	Queen Victoria Square	KP, Dom, Jimax	4		
	Royal Academy dance in station?									
		Star Events	Strike Underpass rigging	08:00	11:00	Underpass	KP, Dom, Jimax	4	7.5t	
		Star Events	Ferry to Boneyard	08:00	11:00	Underpass	KP, Dom, Jimax	4	7.5t	
		Bluman	Load out PJ's & control T2	09:00	12:00	The Deep	Dom & Tom	4		
		Bluman	Load out PJ's & control T2	09:00	11:00	Underpass	Dom & Tom	2	LWB	17M BASKET
		DBN	Load out Underpass LX	09:00	11:00	Underpass	Dom & Tom	3		
		DBN	Ferry Underpass LX to Boneyard	09:00	11:00	Production Boneyard	Dom & Tom	3	Y	
		Tube	Strike The Deep audio	09:00	15:00	The Deep	Dom & Tom	2		7M
		Tube	Strike Underpass audio	09:00	15:00	Underpass	Dom & Tom			
		Tube	Strike Whitefriar Gate audio	09:00	15:00	Whitefriar Gate	Dom & Tom			
		Tube	Strike Zebedee's Yard audio	09:00	15:00	Zebedee's Yard	Dom & Tom			
		Tube	Strike SLS audio	09:00	15:00	Zebedee's Yard	Dom & Tom			



MADE IN HULL 2017

**BUILD & BREAK
PHASED PLAN**

**[GROUND
CONTROL]**

CONTENTS

Page 3	Overview
Page 4	Core Operations Team
Page 5 - 12	Schedule Breakdown - Build
Page 13	Rehearsal Days - 29/12/16 - 30/12/16
Page 14	Show Days 01/01/17 - 07/01/17
Page 15 - 18	Schedule Breakdown - Break - 07/01/17
Page 19	Appendices
Page 20	Appendix 1 - Show Plans
Page 21	Appendix 2.1 QVS Show Plan
Page 22	Appendix 2.2 Underpass Show Plan
Page 23	Appendix 2.3 The Deep Show Plan
Page 24	Appendix 2.4 Zebedees Yard Show Plan
Page 25	Appendix 2.5 Scale Lane Staith Show Plan
Page 26	Appendix 3 - Structural Drawings
Page 27	Appendix 3.1 QVS Projection Platforms
Page 28	Appendix 3.2 QVS Front of House Tower
Page 29	Appendix 3.3 QVS Projection Tower
Page 30	Appendix 3.4 QVS Cable Pylon
Page 31	Appendix 3.5 Zebedees Yard Lighting Tower
Page 32	Appendix 3.6 C4DI (The Deep) Projection Platform
Page 33	Appendix 3.7 Underpass Screen Support Small
Page 34	Appendix 3.8 Underpass Screen Support Large
Page 35	Appendix 4 - Hull Production Suppliers
Page 36	Appendix 5 - Plant Schedule
Page 37	Appendix 5 - Plant Schedule continued

OVERVIEW

The purpose of this document is to provide a brief for Hull city council and individual venues with a brief guide to the production schedule for the build and de-rig of Made In Hull; the launch event for Hull 2017.

Should there be any queries on the contents of this brief, please direct all correspondence through Chris Clay in the first instance to be directed to the person(s) responsible for the area with which the matter concerns.

To accompany the brief there are also appendices outlining:- plant movement, temporary structure drawings, site plans & plant working zones to be referenced at will. We have also drawn up technical production information packs for each venue, detailing specific technical specifications. These are available at request.

CORE OPERATIONS TEAM

NAME	COMPANY	ROLE	EMAIL
Amy Newhouse	Ground Control	Health and Safety Manager	amy@groundcontroluk.com
Charlotte Denton	Ground Control	Event Assistant	charlotte@groundcontroluk.com
Chris Clay	Made in Hull	Technical & Operations Director	chris.clay@hull2017.co.uk
Dominic Morris	Ground Control	Technical Production Assistant	dominic@groundcontroluk.com
Jim Gee	Ground Control	Site Manager	jim@groundcontroluk.com
Jon Drape	Ground Control	Ground Control Event Director	jon@groundcontroluk.com
Kate Doyle	Ground Control	Event Manager	kate@groundcontroluk.com
Lindsey Hammond	Made in Hull	Assistant Producer	lindsey.hammond@hull2017.co.uk
Max Douglas	Ground Control	Site Assistant	max@groundcontroluk.com
Niccy Hallifax	Made in Hull	Lead Producer	niccy.hallifax@hull2017.co.uk
Tommy Sheals Barrett	Ground Control	Production Manager	tommy@groundcontroluk.com

SCHEDULE BREAKDOWN

APPENDICES

APPENDIX 1 – SHOW PLANS

APPENDIX 2.1 QVS PHASE PLANS

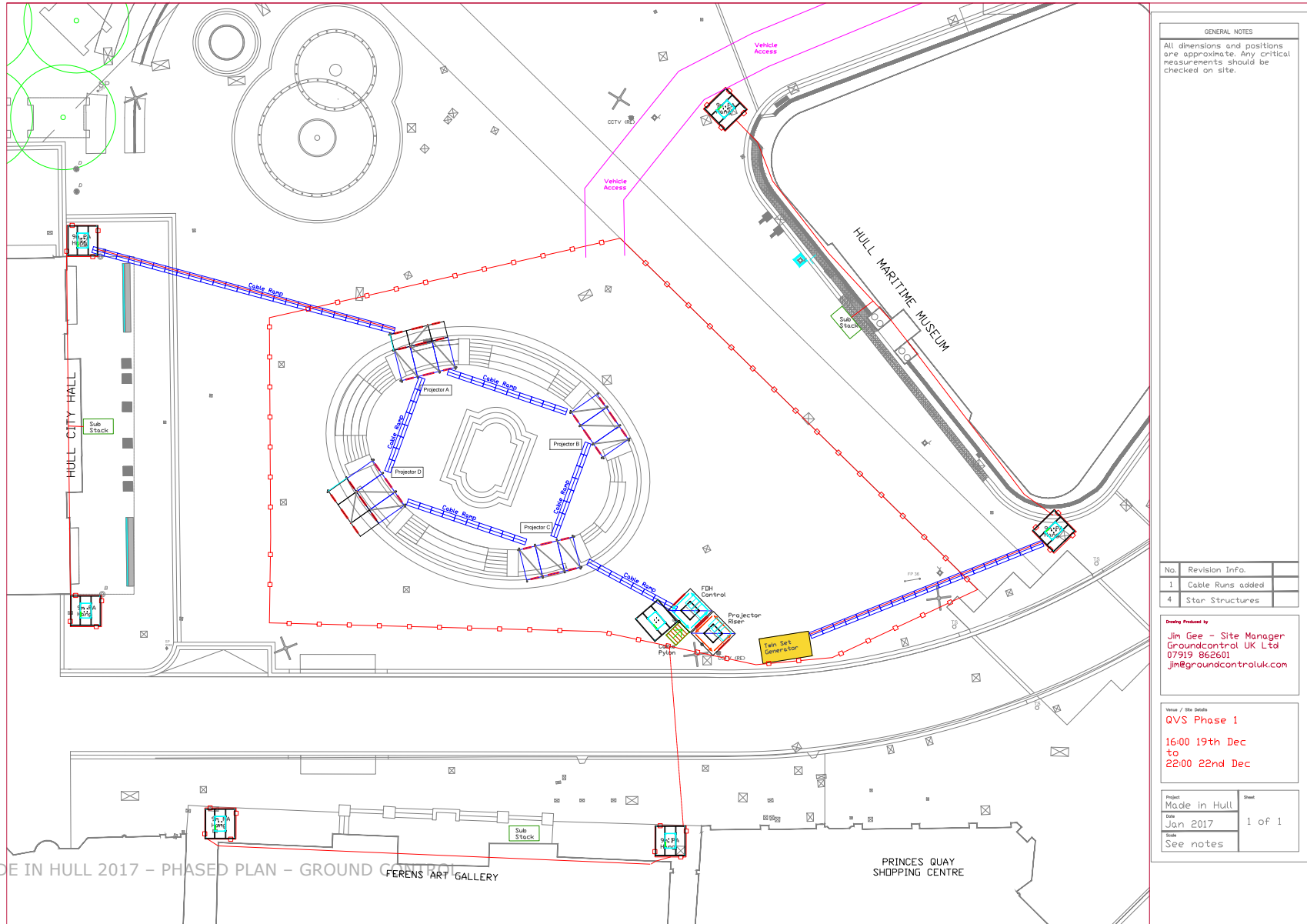

GENERAL NOTES
 All dimensions and positions are approximate. Any critical measurements should be checked on site.

No.	Revision Info.
1	Cable Runs added
4	Star Structures

Drawn / Produced by
 Jim Gee - Site Manager
 Groundcontrol UK Ltd
 07919 862601
 jim@groundcontroluk.com

Issue / Site Details
 QVS Phase 1
 16:00 19th Dec
 to
 22:00 22nd Dec

Project	Sheet
Made in Hull	1 of 1
Date	Jan 2017
Notes	See notes

MADE IN HULL 2017 - PHASED PLAN - GROUND CONTROL

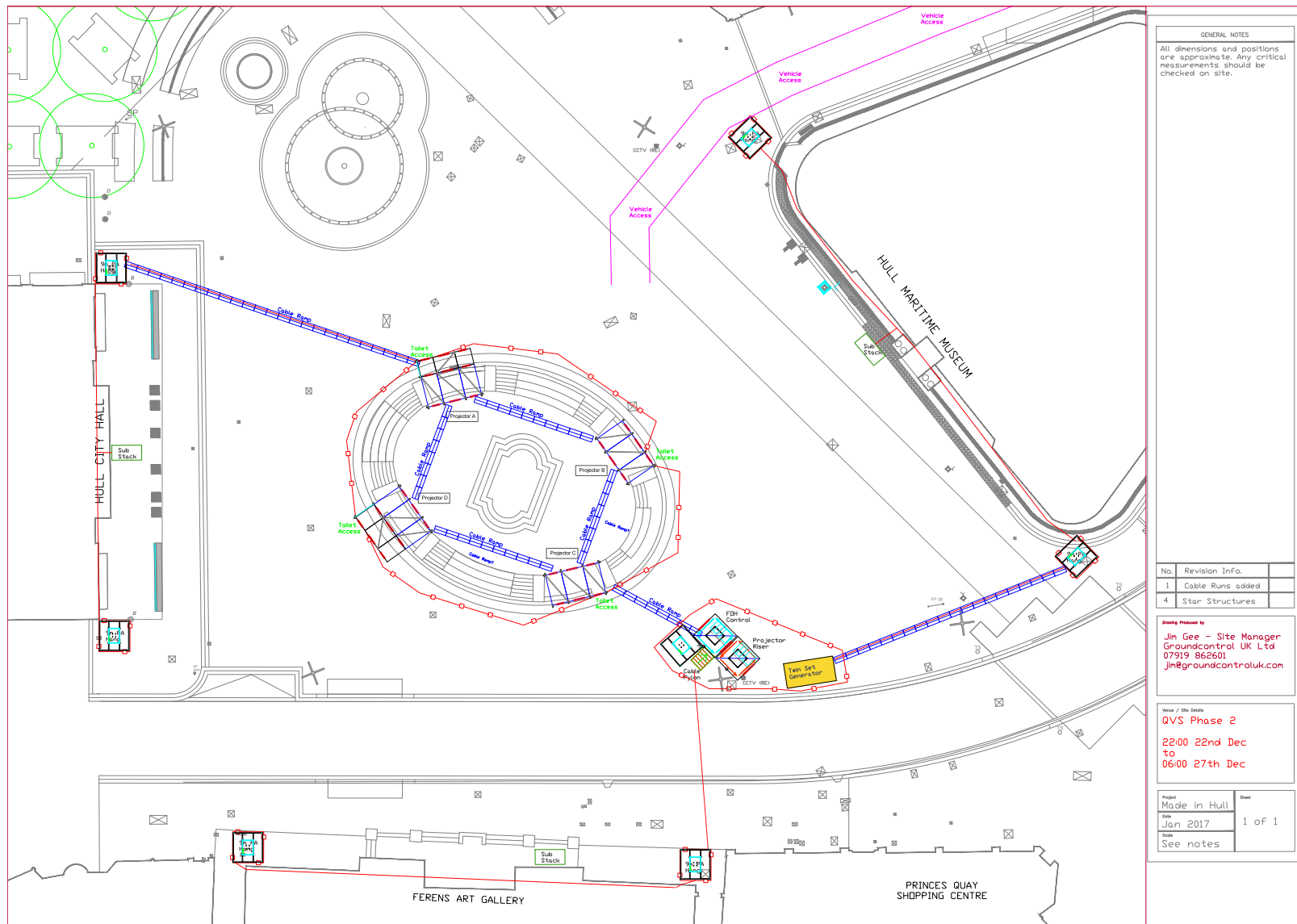

GENERAL NOTES
 All dimensions and positions are approximate. Any critical measurements should be checked on site.

No.	Revision Info.
1	Cable Runs added
4	Star Structures

Drawn Prepared by
 Jim Gee - Site Manager
 Groundcontrol UK Ltd
 07919 862601
 jim@groundcontroluk.com

Work / Site Details
 QVS Phase 2
 22:00 22nd Dec
 to
 06:00 27th Dec

Project	Sheet
Made in Hull	1 of 1
Date	Jan 2017
Scale	See notes

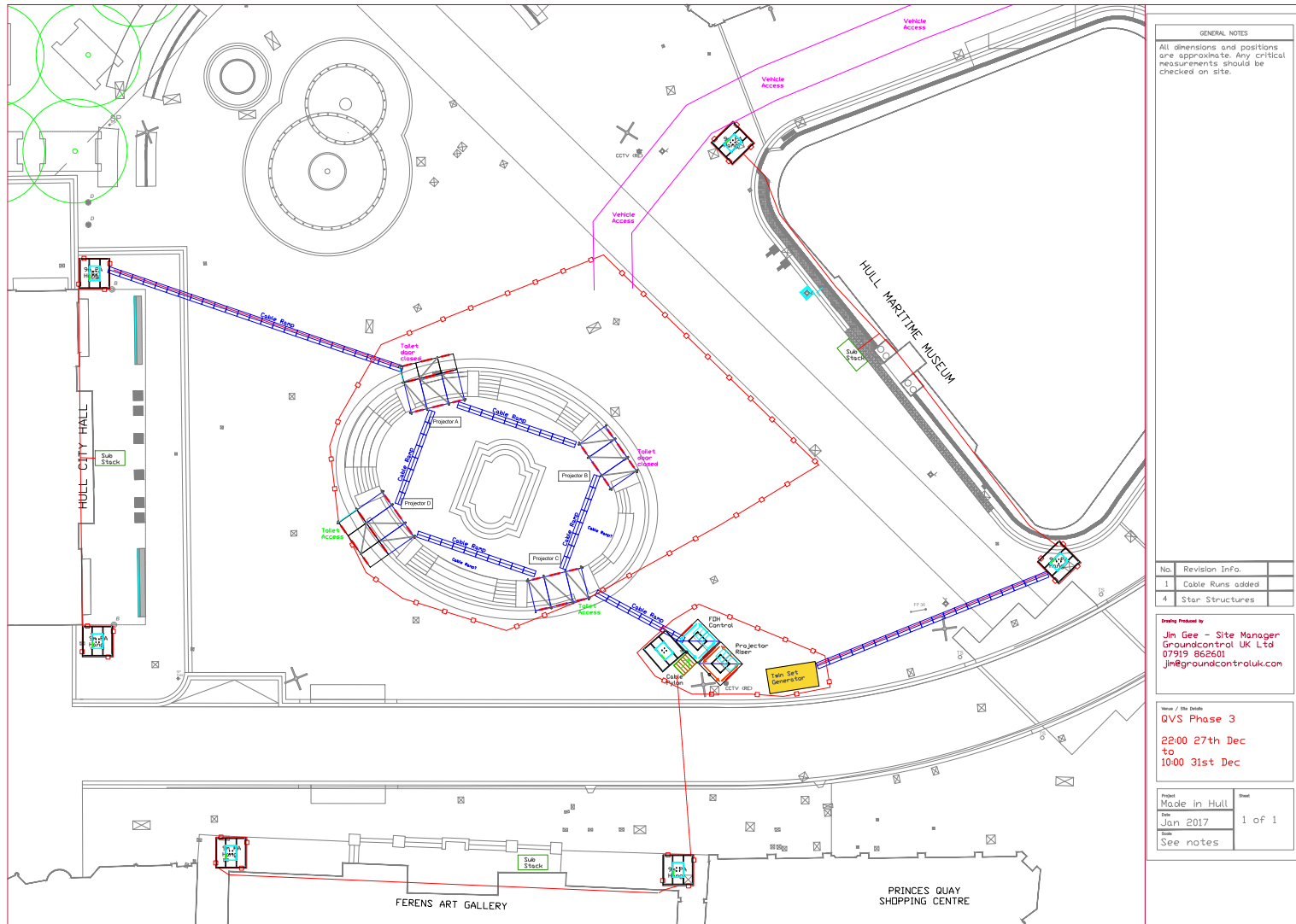

GENERAL NOTES
 All dimensions and positions are approximate. Any critical measurements should be checked on site.

No.	Revision Info.
1	Cable Runs added
4	Star Structures

Created Produced by
 Jim Gee - Site Manager
 Groundcontrol UK Ltd
 07919 862601
 jim@groundcontroluk.com

Name of the Detail
QVS Phase 3
 22:00 27th Dec
 to
 10:00 31st Dec

Project	Sheet
Made in Hull	1 of 1
Date	Jan 2017
Notes	See notes

APPENDIX 2.2 UNDERPASS SHOW PLAN

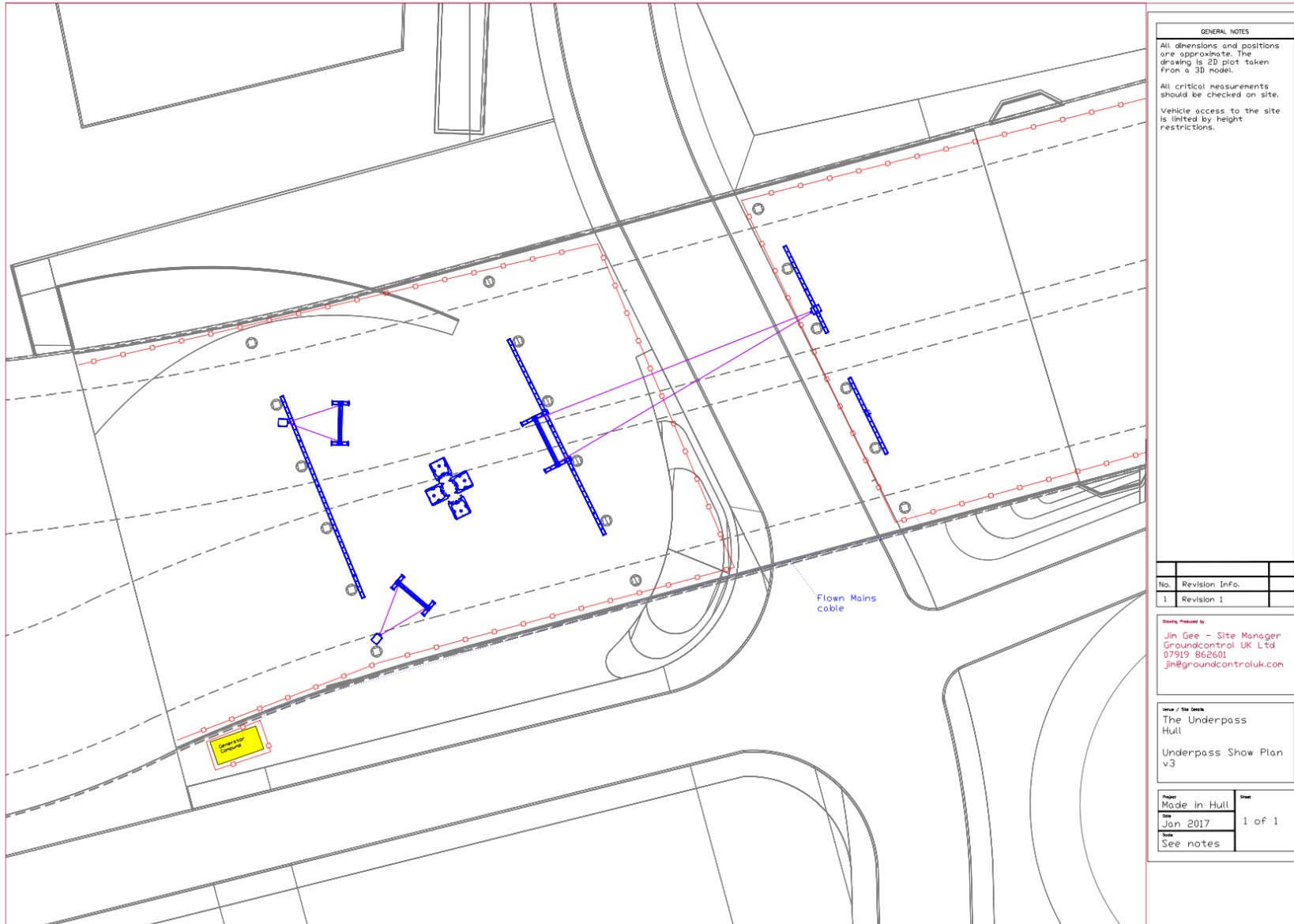

GENERAL NOTES
 All dimensions and positions are approximate. The drawing is 2D plot taken from a 3D model.
 All critical measurements should be checked on site.
 Vehicle access to the site is limited by height restrictions.

No.	Revision Info.
1	Revision 1

Drawn By:
 Jim Gee - Site Manager
 Groundcontrol UK Ltd
 07919 862601
 jim@groundcontroluk.com

Title:
 The Underpass
 Hull
 Underpass Show Plan
 v3

Page	Date	Sheet
Made in Hull	Jan 2017	1 of 1
See notes		

APPENDIX 2.3 THE DEEP SHOW PLAN

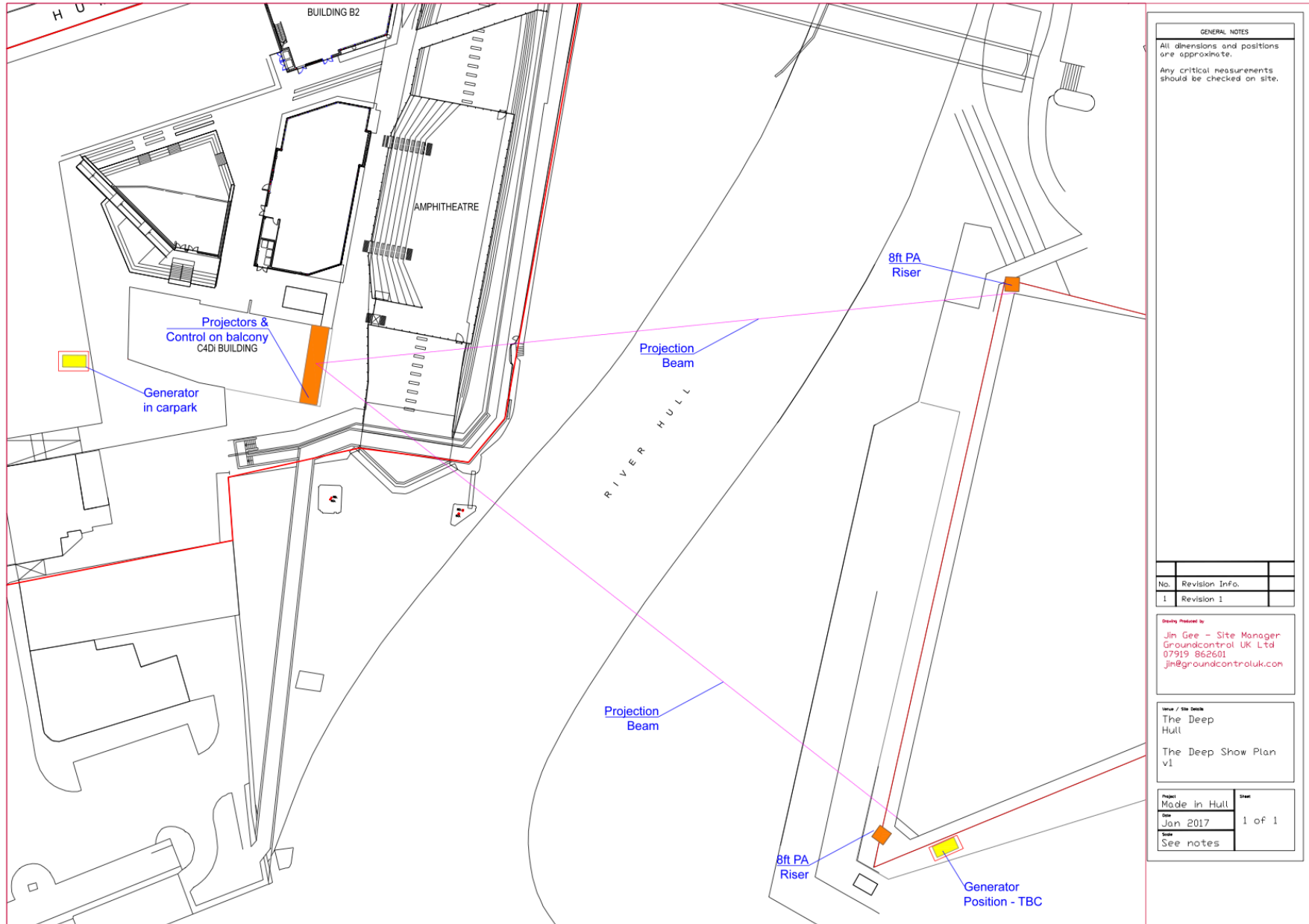

GENERAL NOTES
 All dimensions and positions are approximate.
 Any critical measurements should be checked on site.

No.	Revision Info.
1	Revision 1

Drawn / Produced by:
 Jim Gee - Site Manager
 Groundcontrol UK Ltd
 07919 862601
 jim@groundcontroluk.com

Issue / Site Name:
 The Deep Hull
 The Deep Show Plan v1

Project	Sheet
Made in Hull	1 of 1
Date	Jan 2017
Drawn	See notes

APPENDIX 2.4 ZEBEDEES YARD SHOW PLAN

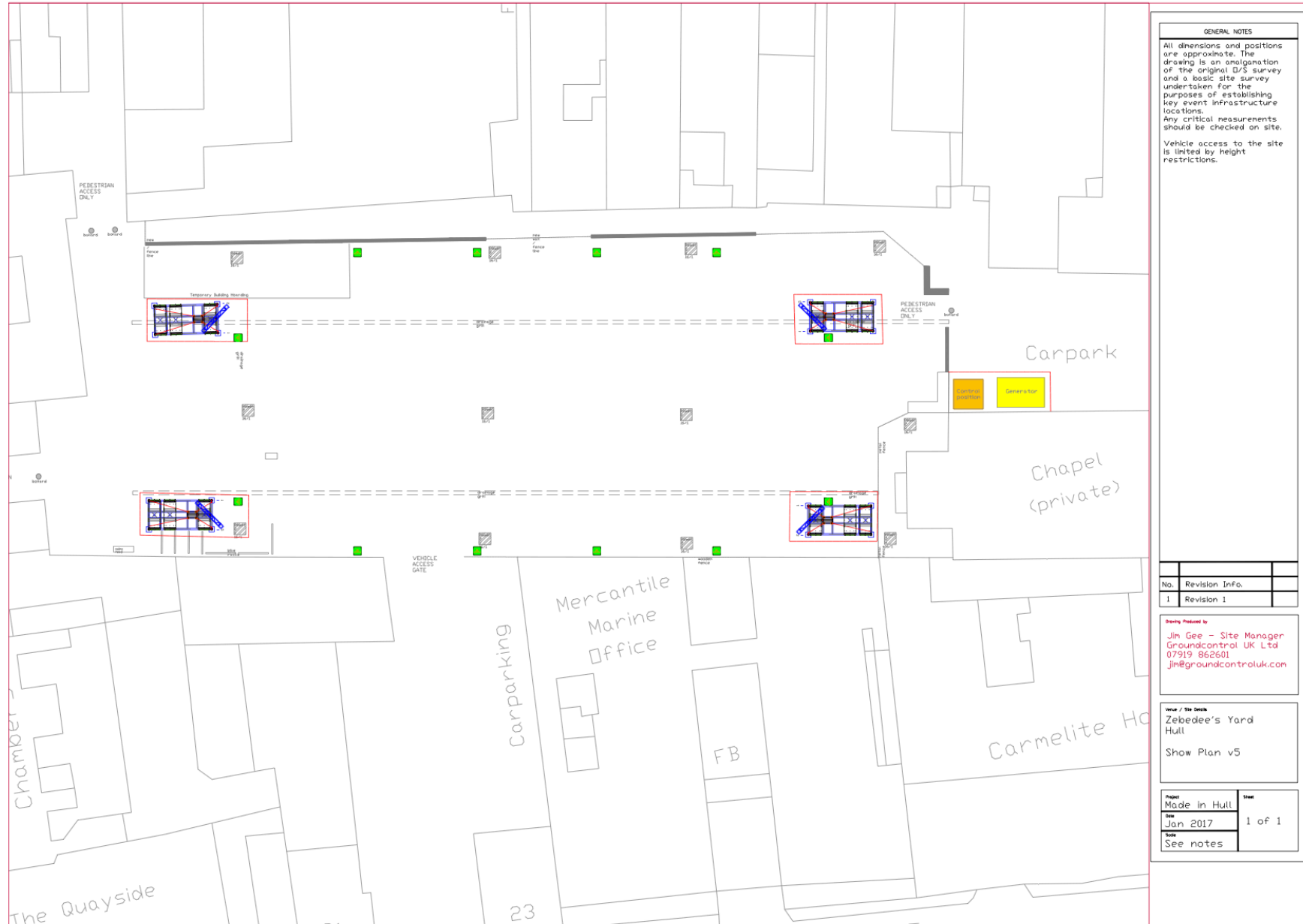

GENERAL NOTES

All dimensions and positions are approximate. The drawing is an amalgamation of the original D/S survey and a basic site survey undertaken for the purposes of establishing key event infrastructure locations. Any critical measurements should be checked on site.

Vehicle access to the site is limited by height restrictions.

No.	Revision Info.
1	Revision 1

Drawn / Produced by
 Jim Gee - Site Manager
 Groundcontrol UK Ltd
 07919 862601
jin@groundcontroluk.com

Work / Site Name
 Zebedee's Yard
 Hull
 Show Plan v5

Project	Sheet
Made in Hull	1 of 1
Date	
Scale	

See notes

APPENDIX 2.5 SCALE LANE STAITH SHOW PLAN

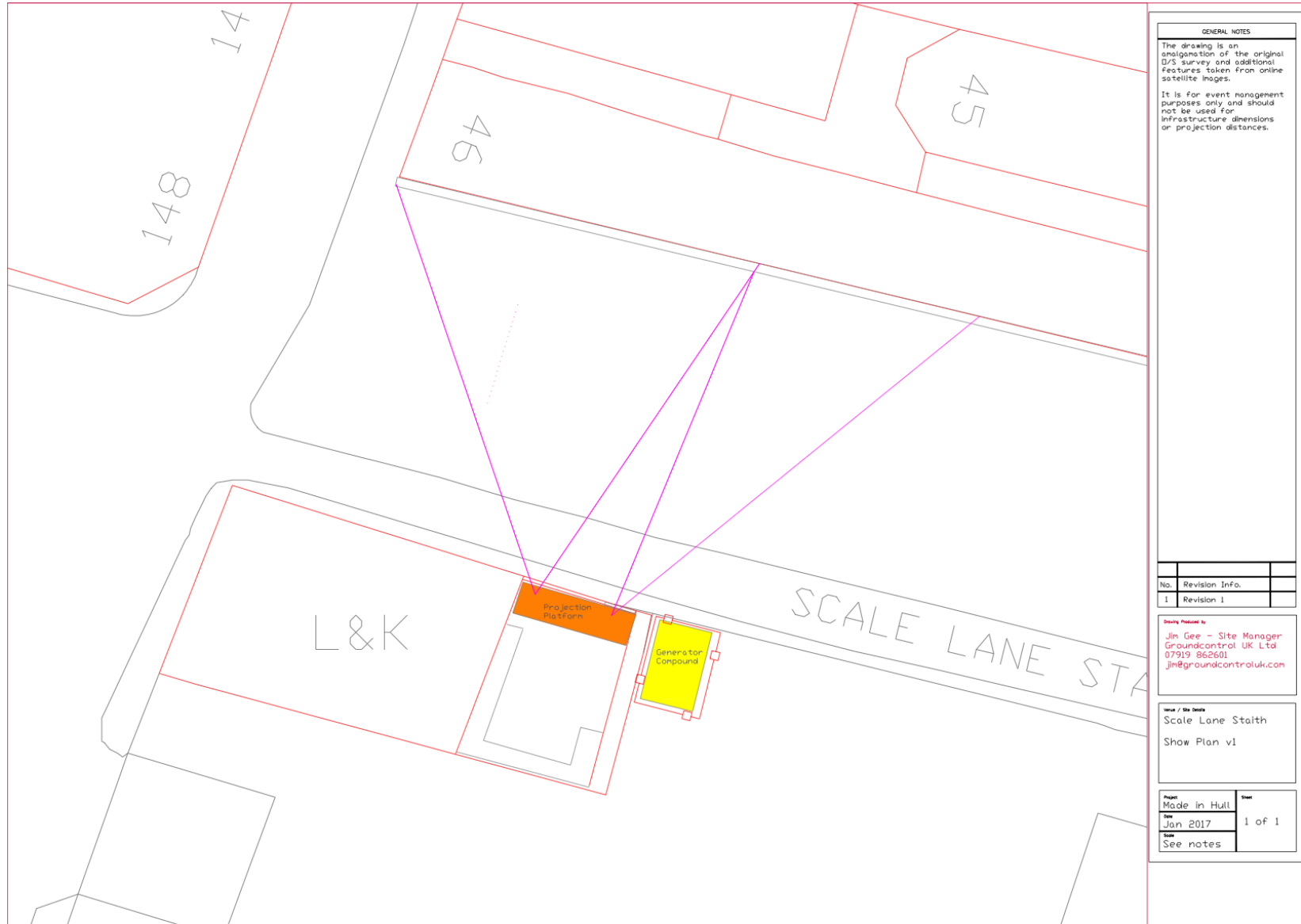

GENERAL NOTES

The drawing is an amalgamation of the original D/S survey and additional Features taken from online satellite images.
It is for event management purposes only and should not be used for infrastructure dimensions or projection distances.

No.	Revision Info.
1	Revision 1

Drawn / Checked by
Jin Gee - Site Manager
Groundcontrol UK Ltd
07919 862601
jin@groundcontroluk.com

Drawn / Site Name
Scale Lane Staith
Show Plan v1

Page	Sheet
Made in Hull	
Date	1 of 1
See	
See notes	

APPENDIX 3 – STRUCTURAL DRAWINGS

APPENDIX 3.1 QVS PROJECTION PLATFORMS

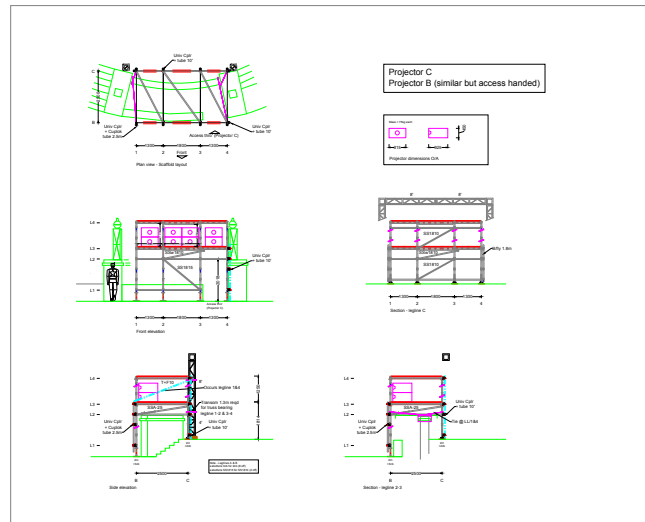
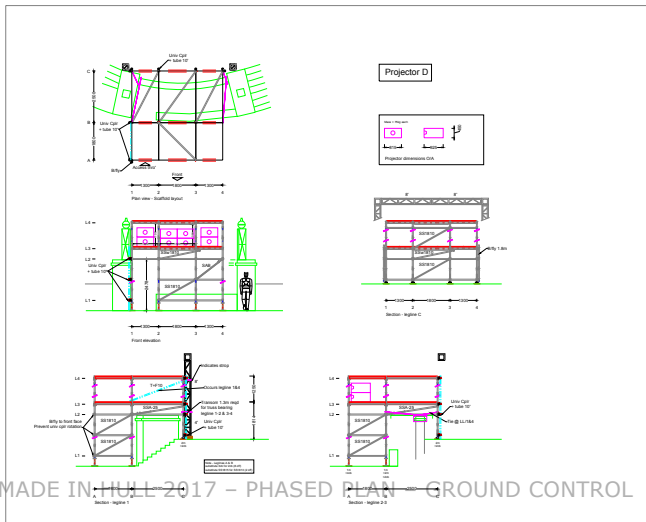
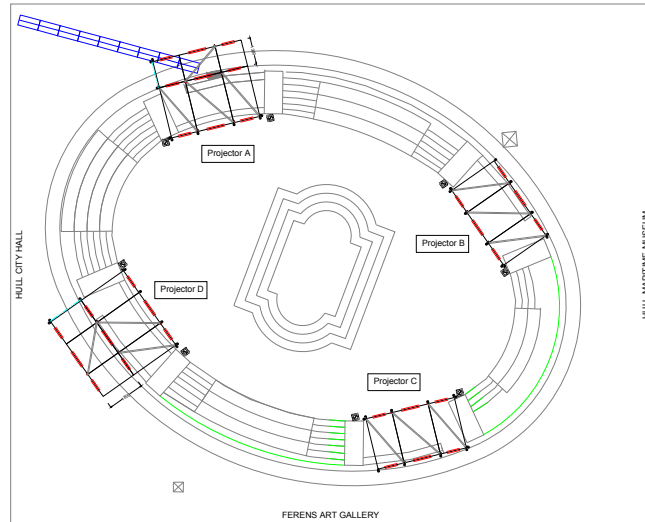
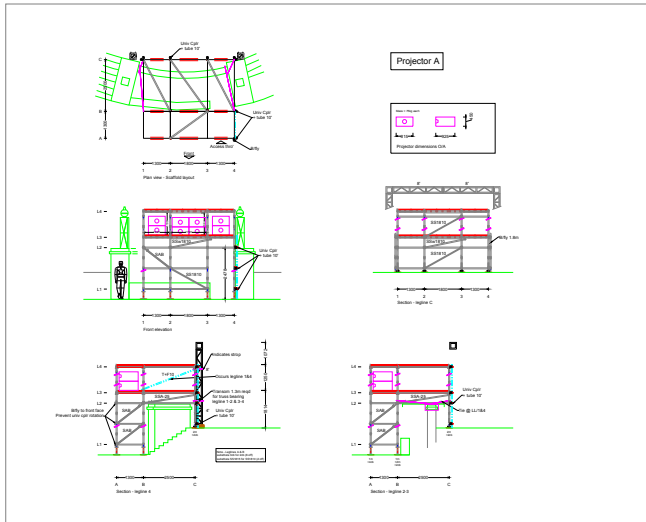

Projecting, Overlays structures, Hoisting & Barriers, Temporary structures, Projector structures, Hoisting, Monorails, Stand structures, Temporary structures, Hoisting & Barriers structures

Key

- Indicates Stern up
- Indicates Flare up
- Pin-joint in vertical
- Guard post
- Truss (orange)
- Location of elevation bearing (arrow indicates L/R)
- Must bracing required in addition to floor bracing

Component bracing

- FR2025 Plan brack 2.5m x 2.5m
- FR2025 Face brack 2.5m x 2.5m
- LAB Long Adjustable brack
- SAB Short Adjustable brack
- SS2010 Snap-Snap 2.5m x 1.5m
- SS2015 Snap-Snap 2.5m x 1.5m
- T4F10 Tube 10" o/w 20ft axial couplers

General Notes

This drawing/document is COPYRIGHT and property of Star Events Ltd. It must not be copied (in whole or in part), used for manufacture or otherwise disposed without the written consent of the company.
Any copies of this drawing/document made by any method must include this legend.

DO NOT SCALE this drawing.

All dimensions mm unless indicated otherwise.
All critical dimensions should be checked on site.

All loads indicated are NOT factored.

Maximum imposed load on floor = 5kN/m²
Maximum load imposed on leg = 31.25kN

All joints in Cuplok verticals should be spigot pinned/bolted.
Bracing arrangements repeat on all leg lines.

Must jack bracing MUST be installed as indicated.

The following supplied information has been used in the preparation of this drawing :-
... Rec'd 16-11-22 QVS Show Plan v1 - JG

It is assumed that the ground level is flat.

Where structures are cladded, all kentledge guys must be installed prior to fixing of any cladding/meeting. During dismantling, kentledge guys should only be removed after removal of any cladding/meeting.

Structure must not be used until the Check Certificate has been completed and signed. Partial utilisation may be possible at the discretion of the Crew Boss or Project Manager.

IMPORTANT
Managed structure

~~The structure is designed in accordance with "Temporary Dismantling Structures 3.2.4" "managed wind conditions" with a maximum speed of 25m/s (50mph) measured at 10m above ground level.~~

~~Should the gust speed exceed 18.0m/s (40mph) in conjunction with an increasing wind, then the structure must be put on alert.~~

~~Should the gust speed exceed 22.0m/s (50mph) in conjunction with an increasing wind, then the cladding must be removed.~~

AS/EN 10134, ASKI

No.	Description	By	Date
1	General Revision	RWF	25-11-18

Star Events Ltd
Millers Road, The Haven
Redford MK44 2DF UK
Tel: +44 1234 772233
www.starevents.co.uk
engineering@starevents.co.uk

QVS Projector Housing Monument structure Made In Hull

Hull
General Arrangement

RWF
23-11-18
Ground Control
1:50 @ A3
Previous

16-11040-01a

MADE IN HULL 2017 - PHASED PLAN - GROUND CONTROL

APPENDIX 3.2 QVS FRONT OF HOUSE TOWER

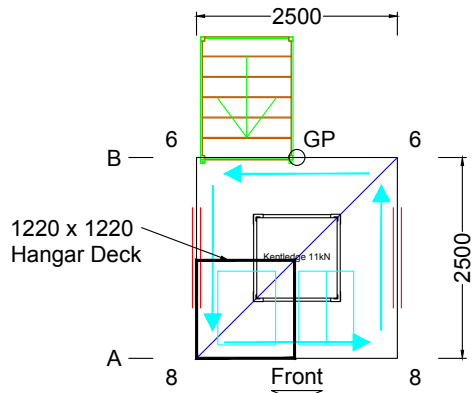

Plan view

Cuplok Verticals
 6 = 1m + 1.8m
 8 = 2m + 1.8m
 GP = Guard Post

Kentledge requirement
 1 off concrete @ 11kN each

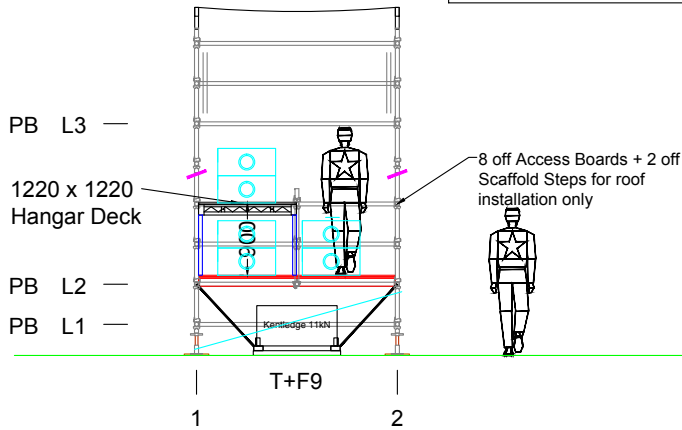

Front elevation

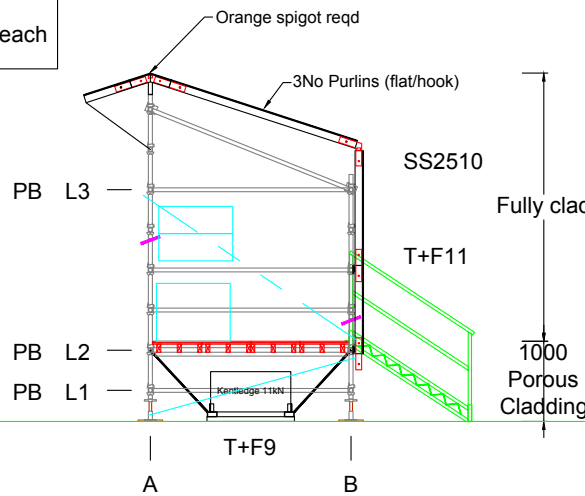
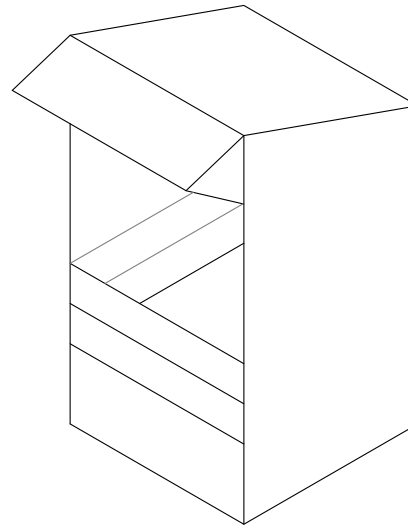

Side elevation

Key

- Indicates Show up
- Indicates Ramp up
- Pinned joint in vertical
- Guard post
- Truss
- Truss (wing)
- Location of abatement bracing (arrow indicates LPT)
- Mast brace required in addition to floor bracing

Component bracing

- F82325 Plan brace 2.5m x 2.5m
- F82330 Face brace 2.5m x 2.5m
- LAR Long Adjustable brace
- S&B Short Adjustable brace
- SS2510 Snap-Strap 2.5m x 1.0m
- SS&S15 Snap-Strap 2.5m x 1.5m
- T+F10 Tube 10' dia S&B swivel coupler

General Notes

This drawing/document is COPYRIGHT and property of Star Events Ltd. It must not be copied (in whole or in part), used for manufacture or otherwise disclosed without the written consent of the company.
 Any copies of this drawing/document made by any method must include this legend.

DO NOT SCALE this drawing.

All dimensions mm unless indicated otherwise.
 All critical dimensions should be checked on site.

All loads indicated are NOT factored.
 Maximum imposed load on floor = 5kN/m²
 Maximum load imposed in leg = 31.25kN

All joints in Cuplok verticals should be spigot-pinned/bolted.
 Bracing arrangements repeat on all leg lines.

Jack bracing may be omitted if jack extension is not greater than:
 LR 2.5m = 300mm
 LR 1.5m = 200mm
 LR 1.0m = 100mm
 Mast jack bracing MUST be installed as indicated.

The following supplied information has been used in the preparation of this drawing:
 ... None supplied.

It is assumed that the ground level is flat.

Where structures are cladsheathed, all kentledge/gys must be installed prior to fixing of any cladding/sheeting.
 During dismantling, kentledge/gys should only be removed after removal of any cladding/sheeting.

Structure must not be used until the Check Certificate has been completed and signed. Partial utilisation may be possible at the discretion of the Crew Boss or Project Manager.

IMPORTANT:
 Managed structure

The structure is designed in accordance with "Temporary Demountable Structures 8.2.4" "managed wind conditions" (i.e. a maximum gust speed of 22m/s (50mph), measured at 10m above ground level).
 Should the gust speed exceed 19.4m/s (43mph), in conjunction with an increasing trend, then SS2510 must be set in place.
 Should the gust speed exceed 22.3m/s (50mph), in conjunction with an increasing trend, then the cladding must be removed.
 If in doubt, ASK!

No.	Description	Date	Issue
001		22-2-22	

Star Events Ltd
 Millers Road, Thrapston
 Bedford MK44 2DF, UK
 Tel: +44 1234 772333
 www.StarEventsUK.com
 info@star-events.co.uk

File	Date
05	23-11-16
06	Ground Control
07	1.50 @ A3
08	Previews

Film & Media structures
 QVS Front of House
 Made in Hull
 Hull
 General Arrangement
 16-11040-02

APPENDIX 3.3 QVS PROJECTION TOWER

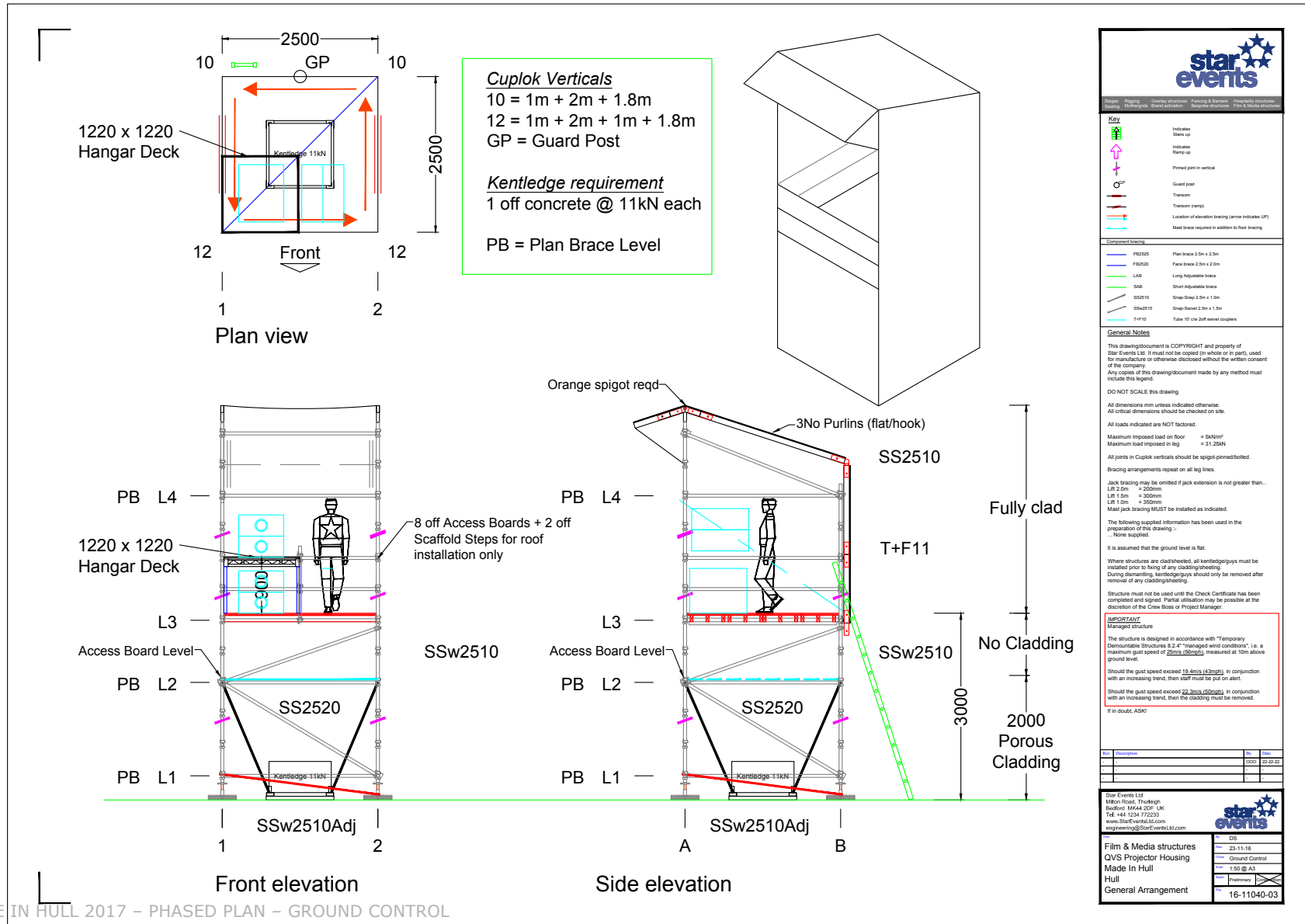

MADE IN HULL 2017 - PHASED PLAN - GROUND CONTROL

APPENDIX 3.4 QVS CABLE PYLON

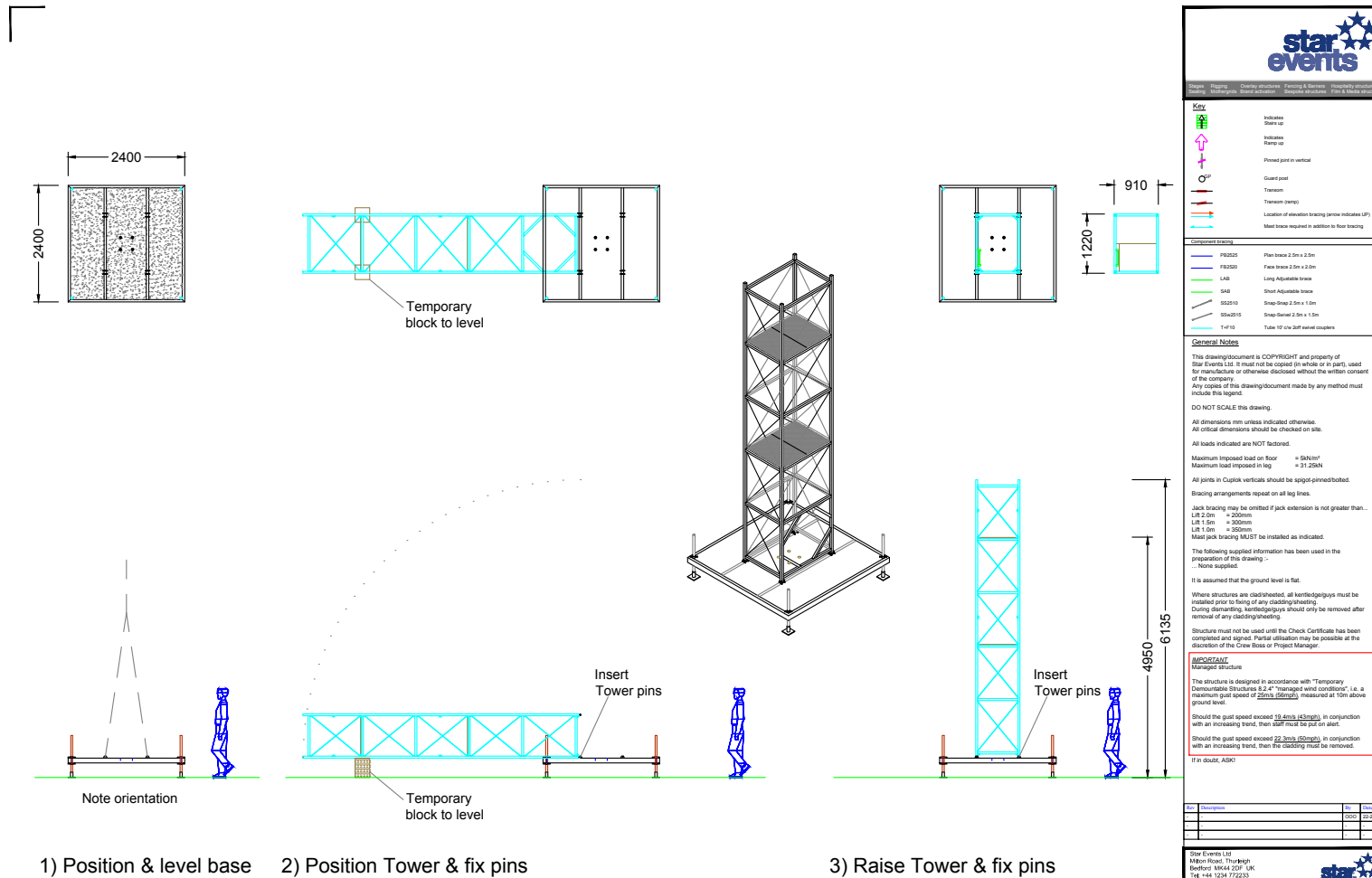

APPENDIX 3.5 ZEBEDEES YARD LIGHTING TOWER

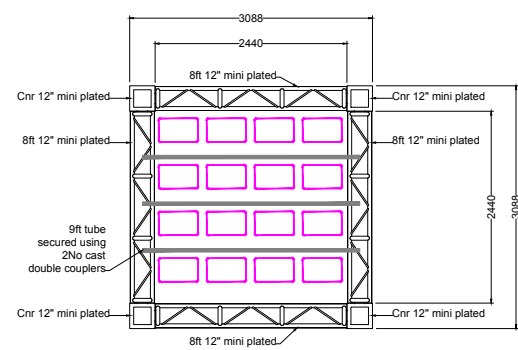
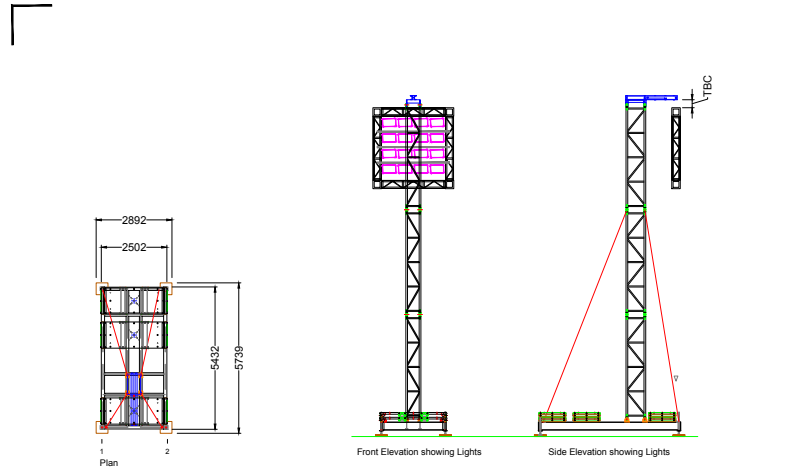

4No Structures Required

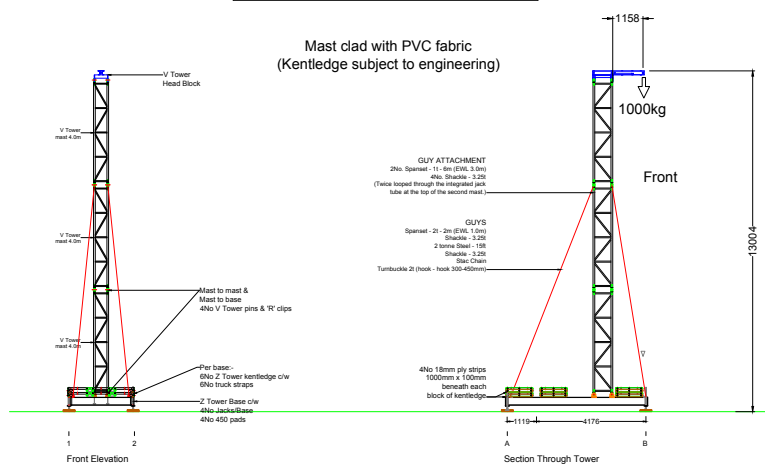

star events

Design structures Planning & Barriers Hospitality of Sites

Key:

- Indicates Stair up
- Indicates Stair up
- Indicates Pinned joint in vertical
- Quarter joint
- Tension
- Tension (wavy)
- Location of vibration bracing (arrow indicates Mast brace required in addition to floor beam)

Component listing:

- FR2015 Flat brace 2.5m x 2.5m
- FR2020 Flat brace 2.5m x 2.5m
- LAB Long Adjustable brace
- SAB Short Adjustable brace
- SS2010 Snap-brace 2.5m x 1.0m
- SS2015 Snap-brace 2.5m x 1.5m
- T1-F10 Tube 10' LW Self-retracting coiler

General Notes

This drawing/document is COPYRIGHT and property of Star Events Ltd. It must not be copied (in whole or in part), used for manufacture or otherwise disclosed without the written consent of the company.

Any copies of this drawing/document made by any method must include this legend.

DO NOT SCALE this drawing.

All dimensions mm unless indicated otherwise. All critical dimensions should be checked on site.

All loads indicated are NOT factored.

Maximum imposed load on floor = 5kN/m²
Maximum load imposed in leg = 31.25kN

All joints in Duplex verticals should be spigot/pinned/bolted.

Bracing arrangements repeat on all leg lines.

Jack bracing may be omitted if jack extension is not greater than:
LH 2.0m = 200mm
LH 1.5m = 300mm
LH 1.0m = 350mm
Mast jack bracing MUST be installed as indicated.

The following supplied information has been used in the preparation of this drawing :-
... None supplied.

It is assumed that the ground level is flat.

Where structures are cladded, all kentledge/guys must be installed prior to fixing of any cladding/bracing. During dismantling, kentledge/guys should only be removed after removal of any cladding/bracing.

Structure must not be used until the Check Certificate has been completed and signed. Partial utilisation may be possible at the discretion of the Crew Boss or Project Manager.

IMPORTANT **TBC**

The structure is designed in accordance with "Temporary Demountable Structures to BS 2447 'Managed Light Conditions', i.e. maximum gust speed of 20m/s (45mph) measured at 10m above ground level.

Should the gust speed exceed 15.0m/s (33mph), in conjunction with an increasing wind, then staff must be put on alert.

Should the gust speed exceed 22.0m/s (50mph), in conjunction with an increasing wind, then the cladding must be removed.

If in doubt, ASK!

Rev	Description	By
1		COO
2		
3		

Star Events Ltd
Milton Road, Thurleigh
Bedford MK44 2DF, UK
Tel: +44 1234 712233
www.StarEventsLtd.com
engineering@StarEventsLtd.com

star events

Film & Media structures
13m Z Tower LX Support
Made In Hull

General Arrangement

DB
23.11.16
Ground Coat
1:75 @ A1
Preliminary
16-1104

APPENDIX 3.6 C4DI (THE DEEP) PROJECTION PLATFORM

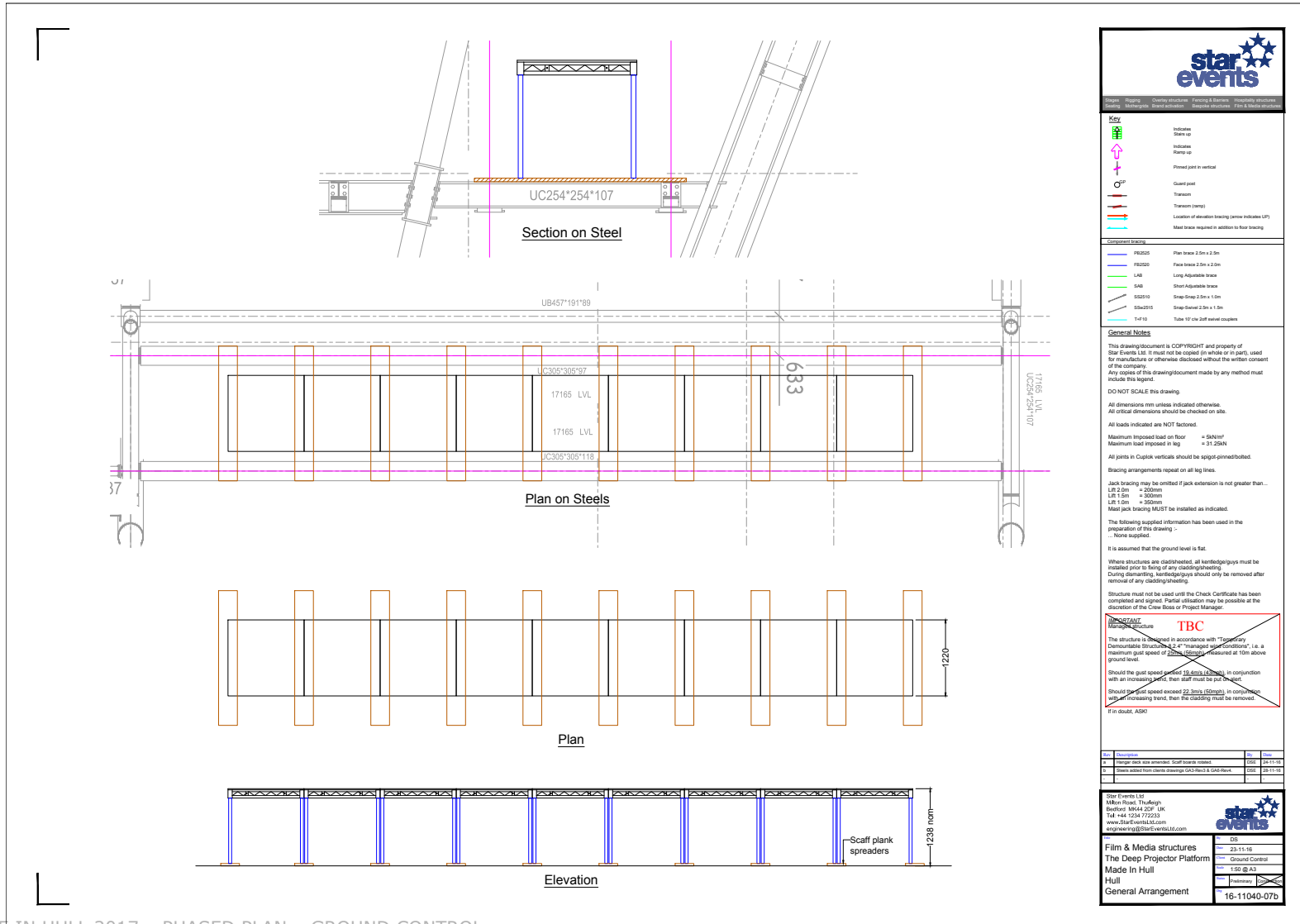

APPENDIX 3.7 UNDERPASS SCREEN SUPPORT SMALL

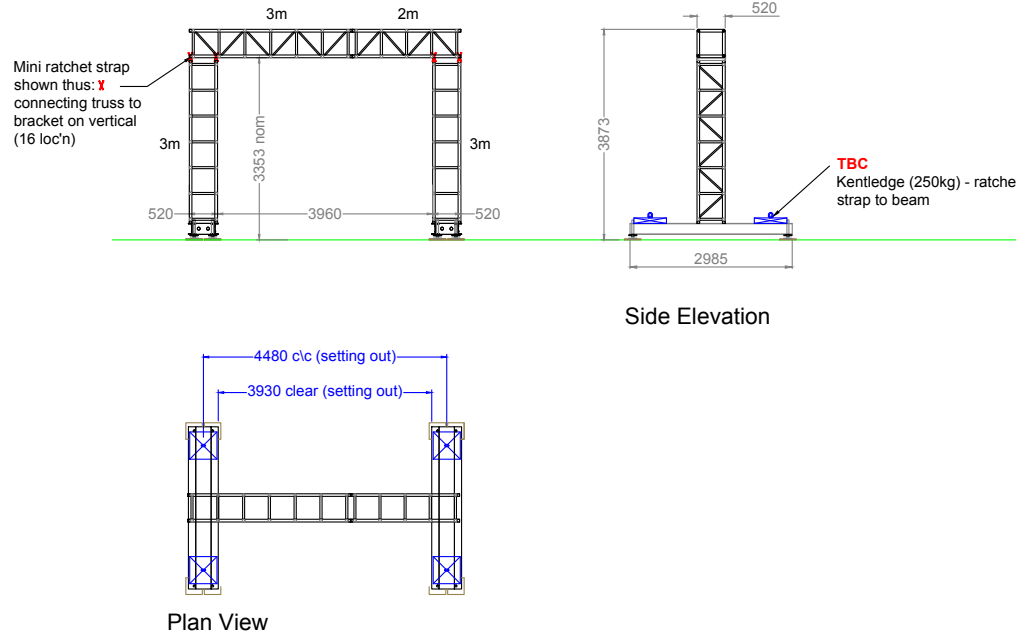

General Notes

This drawing/document is COPYRIGHT and property of Star Events Ltd. It must not be copied in whole or in part, used for manufacture or otherwise disclosed without the written consent of the company.
Any copies of this drawing/document made by any method must include this legend.

DO NOT SCALE this drawing.

All dimensions mm unless indicated otherwise.
All critical dimensions should be checked on site.

All loads indicated are NOT factored.

Maximum imposed load on floor = 5kN/m²
Maximum load imposed in leg = 31.2kN/m

All joints in Cuplok verticals should be spigot/pinned/bolted.

Bracing arrangements repeat on all leg lines.

Jack bracing may be omitted if jack extension is not greater than...

LR 2.0m = 200mm
LR 1.5m = 300mm
LR 1.0m = 350mm

Must jack bracing MUST be installed as indicated.

The following supplied information has been used in the preparation of this drawing -
None supplied.

It is assumed that the ground level is flat.

Where structures are cladded/stepped, all kentledge/gyms must be installed prior to fixing of any cladding/sheeting.
During dismantling, kentledge/gyms should only be removed after removal of any cladding/sheeting.

Structure must not be used until the Check Certificate has been completed and signed. Partial utilisation may be possible at the discretion of the Crew Boss or Project Manager.

IMPORTANT
Managed structures

The structure is designed in accordance with "Temporary Demountable Structures 8.4" "managed wind conditions", i.e. a maximum gust speed of 22.3m/s (50mph) measured at 10m above ground level.

Should the gust speed exceed 19.4m/s (43mph) in conjunction with an increasing trend, then DSE must be put on alert.

Should the gust speed exceed 22.3m/s (50mph), in conjunction with an increasing trend, then the cladding must be removed.

If in doubt, ASB!

No.	Description	By	Date

Star Events Ltd
Millon Road, Thurlough
Beverly NE44 2ST, UK
Tel: +44 1354 772233
www.starevents.co.uk
engineering@starevents.co.uk

Star Structures
Gantry 5m x 3m
Made in Hull
Hull
General Arrangement

DSE
24-11-16
1:50 @ A2
16-11040-09

APPENDIX 3.8 UNDERPASS SCREEN SUPPORT LARGE

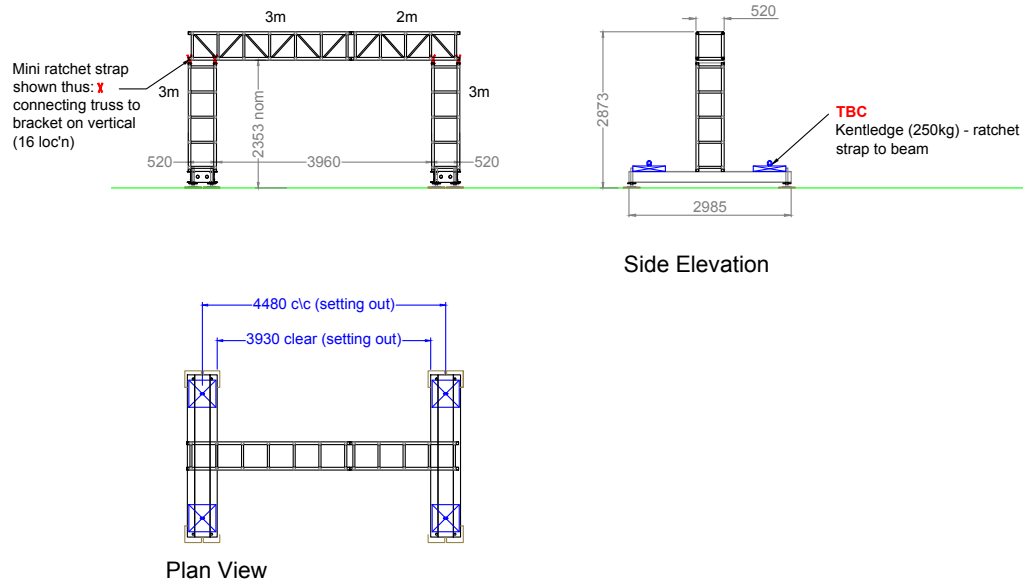



General Notes

This drawing/document is COPYRIGHT and property of Star Events Ltd. It must not be copied in whole or in part, used for manufacture or otherwise disclosed without the written consent of the company. Any copies of this drawing/document made by any method must include this legend.

DO NOT SCALE this drawing.

All dimensions mm unless indicated otherwise. All critical dimensions should be checked on site.

All loads indicated are NOT factors.

Maximum imposed load on floor = 5kN/m²
 Maximum load imposed in leg = 31.25kN

All joints in Coupler verticals should be snug-pinwashed.

Bracing arrangements repeat on all leg lines.

Jack bracing may be omitted if jack extension is not greater than...
 LR 2.0m = 200mm
 LR 1.5m = 200mm
 LR 1.0m = 350mm
 Max jack bracing MUST be installed as indicated.

The following applied information has been used in the preparation of this drawing -
 None supplied.

It is assumed that the ground level is flat.

Where structures are dismantled, all kentledge/gyms must be installed prior to fitting of any cladding/sheeting. During dismantling, kentledge/gyms should only be removed after removal of any cladding/sheeting.

Structure must not be used until the Check Certificate has been completed and signed. Partial utilisation may be possible at the discretion of the Crew Boss or Project Manager.

IMPORTANT

The structure is designed in accordance with "Temporary Demountable Structures 8.2.4" "managed wind conditions", i.e. a maximum gust speed of **19.4m/s (43mph)** measured at 10m above ground level.

Should the gust speed exceed **19.4m/s (43mph)**, in conjunction with an increasing trend, then staff must be put on alert.

Should the gust speed exceed **24.2m/s (54mph)**, in conjunction with an increasing trend, then the cladding must be removed.

If in doubt, ASK!

Star Events Ltd
 Milton Road, Thrapston
 Northants NN64 2DP, UK
 Tel: +44 1524 772233
 www.star-events.co.uk
 engineering@star-events.co.uk



Star Structures	DSE
Sanitary 5m x 2m	24-11-16
Made in Hull	1:50 @ A2
Hull	16-11040-10
General Arrangement	

APPENDIX 4

HULL - PRODUCTION SUPPLIERS

ROLE	COMPANY	SITE CONTACT
AUDIO	Tube	Melv Coote
LIGHTING	DBN	Nick Walton
PROJECTION & VIDEO	Bluman Associates	Simon Hudson
STRUCTURES & RIGGING	Star Events	Pete Holdich
POWER	Midas	David Noble

APPENDIX 5 – PLANT SCHEDULE

DATE	DEPARTMENT	ACTIVITY	LOCATION	PLANT REQUIRED	REQUIRED FROM	REQUIRED UNTIL
19/12/2016	SITE & PRODUCTION	TRUCK UNLOADING & CROSSLOADING	BONEYARD	926	ALL DAY	ALL DAY
19/12/2016	STAR EVENTS	TRUCK CROSSLOADING	BONEYARD	926	11:00	12:00
19/12/2016	STAR EVENTS	TRUCK UNLOADING	SLS	7M	13:00	16:00
19/12/2016	STAR EVENTS	TRUCK UNLOADING	QVS	7M	19:00	20:00
20/12/2016	STAR EVENTS	TRUCK UNLOADING	QVS	7M	ALL DAY	ALL DAY
20/12/2016	SITE & PRODUCTION	TRUCK UNLOADING & CROSSLOADING	BONEYARD	926	ALL DAY	ALL DAY
21/12/2016	PRODUCTION	WINDOW SCREENING	QVS	TRUCK MOUNT	ALL DAY	ALL DAY
21/12/2016	STAR EVENTS	TRUCK UNLOADING	QVS	7M	ALL DAY	ALL DAY
21/12/2016	SITE & PRODUCTION	TRUCK UNLOADING & CROSSLOADING	BONEYARD	926	ALL DAY	ALL DAY
22/12/2016	TUBE	CABLE INSTALL	QVS	17MW/BASKET	08:00	18:00
22/12/2016	STAR EVENTS	TRUCK UNLOADING	ZEBEDEE'S YARD	7M	08:00	13:00
22/12/2016	STAR EVENTS	TRUCK CROSSLOADING	BONEYARD	926	18:00	18:30
22/12/2016	SITE & PRODUCTION	TRUCK UNLOADING & CROSSLOADING	BONEYARD	926	ALL DAY	ALL DAY
23/12/2016	STAR EVENTS	RIGGING INSTALL	UNDERPASS	17MW/BASKET	08:00	13:00
23/12/2016	SITE & PRODUCTION	TRUCK UNLOADING & CROSSLOADING	BONEYARD	926	ALL DAY	ALL DAY
27/12/2016	BLUMAN	PROJECTOR INSTALL	UNDERPASS	17MW/BASKET	12:00	16:00
27/12/2016	BLUMAN	PROJECTOR INSTALL	SLS	7M	12:00	16:00
27/12/2016	DBN	LX INSTALL	ZEBEDEE'S YARD	60'PICKER	13:00	19:00
27/12/2016	SITE & PRODUCTION	TRUCK UNLOADING & CROSSLOADING	BONEYARD	926	ALL DAY	ALL DAY
28/12/2016	TUBE	AUDIO INSTALL	THE DEEP	7M	08:00	10:00
28/12/2016	DBN	LX INSTALL	UNDERPASS	17MW/BASKET	14:00	19:00
28/12/2016	SITE & PRODUCTION	TRUCK UNLOADING & CROSSLOADING	BONEYARD	926	ALL DAY	ALL DAY

29/12/2016	SITE & PRODUCTION	TRUCK UNLOADING & CROSSLOADING	BONEYARD	926	ALL DAY	ALL DAY
30/12/2016	SITE & PRODUCTION	TRUCK UNLOADING & CROSSLOADING	BONEYARD	926	ALL DAY	ALL DAY
07/12/2016	ALL	TRUCK LOADING	QVS	7M&17M	21:00	04:00
08/02/2017	SITE & PRODUCTION	TRUCK UNLOADING & CROSSLOADING	BONEYARD	926	ALL DAY	ALL DAY
08/02/2017	BLUMAN	PROJECTOR DERIG	UNDERPASS	17MW/BASKET	09:00	11:00
08/02/2017	DBN	LX DERIG	UNDERPASS	60'PICKER	09:00	11:00
08/02/2017	TUBE	AUDIO DERIG	THE DEEP	7M	09:00	11:00
08/02/2017	BLUMAN	PROJECTOR DERIG	SLS	7M	11:00	13:00
08/02/2017	STAR EVENTS	TRUCK LOADING	SLS	7M	11:00	13:00
08/02/2017	DBN	LX DERIG	ZEBEDEE'S YARD	60'PICKER	11:00	13:00
09/02/2017	STAR EVENTS	TRUCK LOADING	ZEBEDEE'S YARD	7M	08:00	14:00
09/02/2017	STAR EVENTS	PA TOWER DERIG	QVS	7M	14:00	17:00
09/02/2017	SITE & PRODUCTION	TRUCK UNLOADING & CROSSLOADING	BONEYARD	926	ALL DAY	ALL DAY
10/02/2017	SITE & PRODUCTION	TRUCK UNLOADING & CROSSLOADING	BONEYARD	926	ALL DAY	ALL DAY